

# Distributorless Ignition System Adapter User Manual

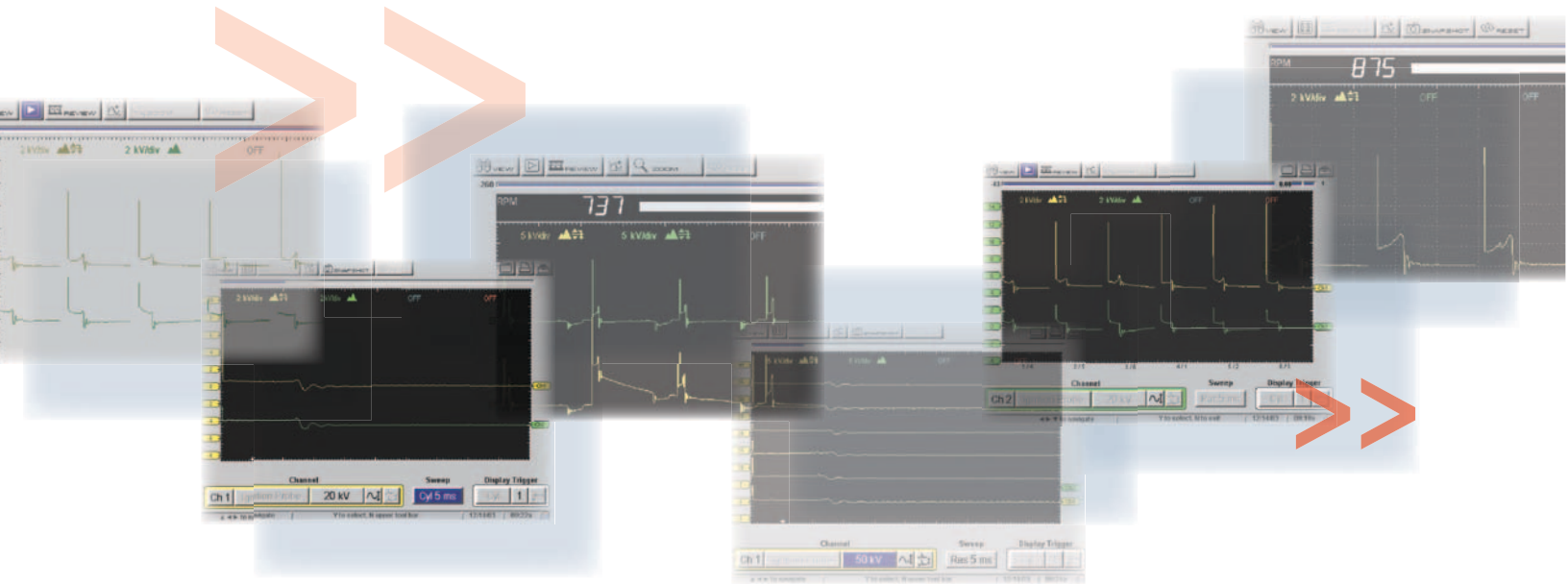

# **Distributorless Ignition System Adapter User Manual**

**November 2009**

**ZEETA309A15 Rev. D**

---

## Trademarks

MODIS and Snap-on are trademarks of Snap-on Incorporated, registered in the United States and other countries. All other marks are trademarks or registered trademarks of their respective holders.

## Copyright Information

©2009 Snap-on Incorporated. All rights reserved.

## Disclaimer of Warranties and Limitation of Liabilities

The information, specifications and illustrations in this manual are based on the latest information available at the time of printing. While the authors have taken due care in the preparation of this manual, nothing contained herein:

- Modifies or alters in any way the standard terms and conditions of the purchase, lease, or rental agreement under the terms of which the equipment to which this manual relates was acquired.
- Increases in any way the liability to the customer or to third parties.

Snap-on reserves the right to make changes at any time without notice.

---

### IMPORTANT:

Before operating or maintaining this unit, please read this manual carefully paying extra attention to the safety warnings and precautions.

---

### Visit our websites at:

[snaon.com](http://snaon.com) (North America)

[snaondiag.com](http://snaondiag.com) (United Kingdom)

[sun-diagnostics.com](http://sun-diagnostics.com) (United Kingdom)

### For Technical Assistance Call

1-800-424-7226 (North America)

CALL +44 (0) 845 601 4736 (United Kingdom)

E-mail [DiagnosticsUKproductsupport@snaon.com](mailto:DiagnosticsUKproductsupport@snaon.com) (United Kingdom)

For technical assistance in all other markets, contact your selling agent.

# Safety Information

For your own safety and the safety of others, and to prevent damage to the equipment and vehicles upon which it is used, it is important that these Safety Messages be read and understood by all persons operating, or coming into contact with, the equipment.

This product is intended for use by properly trained and skilled professional automotive technicians. The safety messages presented throughout this manual are reminders to the operator to exercise extreme care when using this test instrument.

There are many variations in procedures, techniques, tools, and parts for servicing vehicles, as well as in the skill of the individual doing the work. Because of the vast number of test applications and variations in the products that can be tested with this instrument, we cannot possibly anticipate or provide advice or safety messages to cover every situation. It is the automotive technician's responsibility to be knowledgeable of the system being tested. It is essential to use proper service methods and test procedures. It is important to perform tests in an appropriate and acceptable manner that does not endanger your safety, the safety of others in the work area, the equipment being used, or the vehicle being tested.

It is assumed that the operator has a thorough understanding of vehicle systems before using this product. Understanding of these system principles and operating theories is necessary for competent, safe and accurate use of this instrument.

Before using the equipment, always refer to and follow the safety messages and applicable test procedures provided by the manufacturer of the vehicle or equipment being tested. Use the equipment only as described in this manual.

Read, understand and follow all safety messages and instructions in this manual, the accompanying safety manual, and on the test equipment.

## Safety Message Conventions

Safety messages are provided to help prevent personal injury and equipment damage. All safety messages are introduced by a signal word indicating the hazard level.

### **DANGER**

Indicates an imminently hazardous situation which, if not avoided, will result in death or serious injury to the operator or to bystanders.

### **WARNING**

Indicates a potentially hazardous situation which, if not avoided, could result in death or serious injury to the operator or to bystanders.

### **CAUTION**

Indicates a potentially hazardous situation which, if not avoided, may result in moderate or minor injury to the operator or to bystanders.

Safety messages contain three different type styles.

- Normal type states the hazard.
- Bold type states how to avoid the hazard.
- Italic type states the possible consequences of not avoiding the hazard.

An icon, when present, gives a graphical description of the potential hazard.

Example:

## **WARNING**



Risk of unexpected vehicle movement.

- **Block drive wheels before performing a test with engine running.**

*A moving vehicle can cause injury.*

## **Important Safety Instructions**

For a complete list of safety messages, refer to the accompanying safety manual.

# **SAVE THESE INSTRUCTIONS**

# Contents

<b>Safety Information</b> .....	<b>iii</b>
<b>Contents</b> .....	<b>v</b>
<b>Chapter 1: Using This Manual</b> .....	<b>1</b>
Conventions .....	1
Bold Text .....	1
Symbols .....	1
Terminology .....	2
Notes and Important Messages .....	2
Procedures .....	2
<b>Chapter 2: Introduction</b> .....	<b>3</b>
Functional Description .....	3
Kit Contents .....	3
Layout .....	5
<b>Chapter 3: Getting Started</b> .....	<b>7</b>
Connecting to the Diagnostic Tool .....	7
DIS Adapter Operation .....	7
Preparing the Vehicle .....	8
Connecting to Coil and Plug Wires .....	8
Connecting to Coils or Caps .....	9
Coil Pickups .....	9
Connecting to Ignition Systems .....	12
<b>Chapter 4: Operation</b> .....	<b>17</b>
Interpreting test results .....	17
Troubleshooting .....	17
Polarity Issues .....	18
Wasted Spark Systems .....	19
Synchronization .....	19
Inverted Signal .....	20
Pickup Not Connected to a Cylinder .....	21
Incorrect polarity setup .....	21
Reversed Measuring Leads .....	22
<b>Chapter 5: Maintenance</b> .....	<b>23</b>
Disposal of the DIS Adapter .....	23
<b>Appendix A: Ignition Waveforms</b> .....	<b>25</b>
The Ignition Cycle .....	26
<b>Appendix B: Coil Adapters</b> .....	<b>29</b>
Coil-in-cap Adapters .....	29
Coil-on-plug Adapters .....	30
<b>Appendix C: Coil Information</b> .....	<b>37</b>



This manual contains instructions for using the DIS Adapter.

Some of the illustrations shown in this manual may contain modules and optional equipment that are not included on your system. Contact your sales representative for availability of other modules and optional equipment.

## 1.1 Conventions

The following conventions are used.

### 1.1.1 Bold Text

Bold emphasis is used in procedures to highlight selectable items such as buttons and menu options.

Example:

- Press the **Y/✓** button.

### 1.1.2 Symbols

Different types of arrows are used.

The “greater than” arrow (>) indicates an abbreviated set of selection instructions.

Example:

- Select **Utilities > Tool Setup > Date**.

The example statement abbreviates the following procedure:

1. Navigate to the **Utilities** button.
2. Use the Thumb Pad to navigate to and highlight the **Tool Setup** submenu.
3. Use the Thumb Pad to navigate to and highlight the **Date** option from the submenu.
4. Press **Y/✓** to confirm the selection.

The solid arrows (◀, ▶, ▼, ▲) are navigational instructions referring to the four directions of the Thumb Pad.

Example:

- Press the down ▼ arrow.



### 1.1.3 Terminology

The term “select” means highlighting a button or menu item using the Thumb Pad and pressing the **Y/✓** button to confirm the selection.

Example:

- Select **Reset**.

The above statement abbreviates the following procedure:

1. Navigate to and highlight the **Reset** button.
2. Press the **Y/✓** button.

### 1.1.4 Notes and Important Messages

The following messages are used.

#### Notes

A NOTE provides helpful information such as additional explanations, tips, and comments.

Example:

**NOTE:**

For additional information refer to...

---

#### Important

IMPORTANT indicates a situation which, if not avoided, may result in damage to the test equipment or vehicle.

Example:

---

**IMPORTANT:**

Do not force the CompactFlash<sup>®</sup> card into the slot.

---

### 1.1.5 Procedures

An arrow icon indicates a procedure.

Example:

**To change screen views:**

1. Select the **View button**.  
The drop-down menu displays.
2. Select an option from the menu.  
The screen layout changes to the format you selected.

The DIS Adapter is designed to be used with the MODIS™ Lab Scope Plug-in. Refer to the appropriate tool manual for operational information.

## 2.1 Functional Description

The DIS Adapter relays the signals from pickups as input to the MODIS Lab Scope Plug-in. The scope processes the signals and displays them on the screen. The DIS Adapter can be used to sample and display the following ignition types secondary ignition signals:

- Distributor—with one or more coils and distributors or the coil fitted in the distributor cap.
- Wasted Spark—with one coil for every 2 spark plugs.
- Direct—with one coil per spark plug.

## 2.2 Kit Contents

Please refer to the Contents List that came with the kit for the exact contents. Contact your sales representative for (optional) pickups.

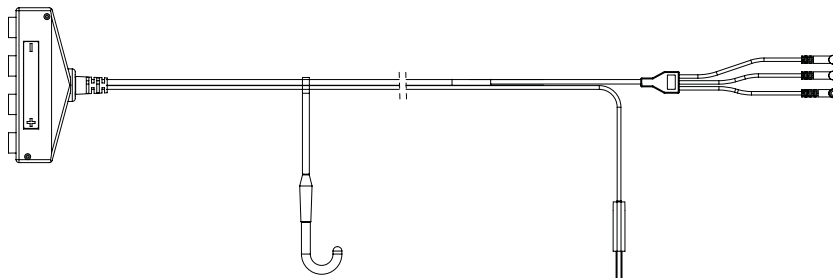

**Figure 2-1** EAA0274E05A—Secondary Connection Box DIS Adapter



---

**NOTE:**

Two different dual pickup cable assemblies do exist. Please ensure to apply one type only when connecting multiple dual pickup cable assemblies to the DIS Adapter.

---

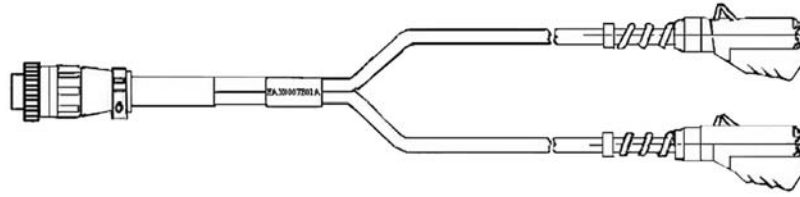

**Figure 2-2** EAX0007B01A—Dual pickup cable assembly (grey)

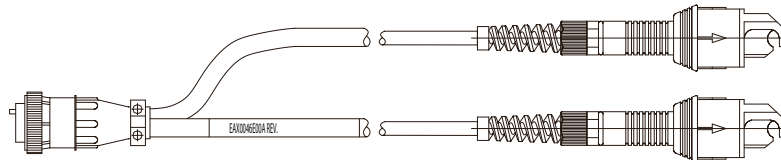
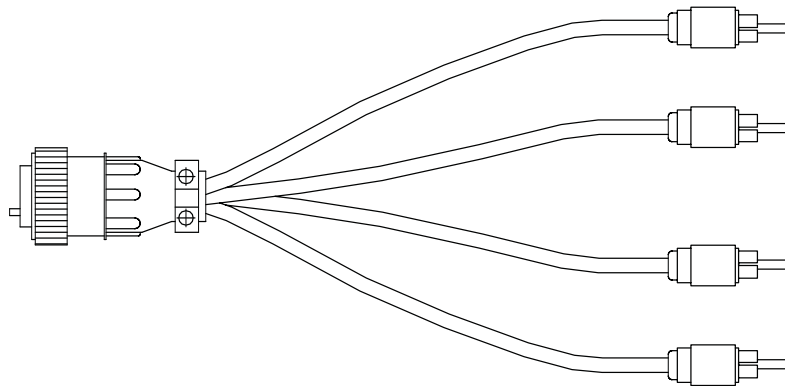

**Figure 2-3** EAX0046E00A—Dual pickup cable assembly (black)



**NOTE:**

When ordering replacement dual pickup cable assemblies note the type of probe, the color of the cable, and the part number stamped on the cable to ensure the correct cable is ordered.

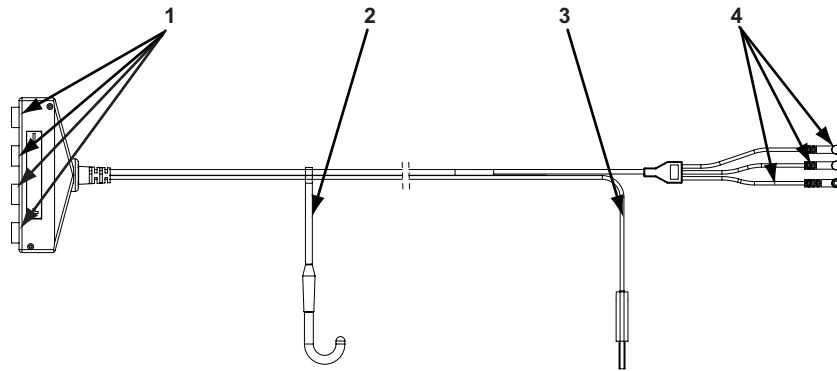

**Figure 2-4** EAX0046F01A—Quad adapter lead assembly V3



**Figure 2-5** 2-12203A—Phono adapter female/female

## 2.3 Layout



- 1— Connectors for positive (2 off) and negative (2 off) firing secondary signals. Polarity is shown on the adapter.
- 2— Hood hook
- 3— Connector for vehicle ground
- 4— Connectors to the MODIS Lab Scope Plug-in

**Figure 2-6** *DIS Adapter layout*

Connectors are color coded on the DIS Adapter and MODIS Lab Scope Plug-in as shown in the table below:

**Table 2-1** *DIS adapter connections*

Item	Connect to
Yellow connector	CH1 (yellow)
Green connector	CH2 (green)
Black connector	GND (black)
Alligator clamp	Vehicle ground



This chapter describes how to connect the DIS Adapter to the vehicle ignition system and the MODIS Lab Scope Plug-in. Optional pickups may be required.

---

**IMPORTANT:**

Read and understand the MODIS Lab Scope Plug-in manuals before proceeding.

---

## 3.1 Connecting to the Diagnostic Tool

Prior to connecting the DIS Adapter to the MODIS Lab Scope Plug-in, check:

- integrity of the wires
- integrity of the pins and connectors.

Connect the color-coordinated connectors of the DIS Adapter to the corresponding port on the MODIS Lab Scope Plug-in.

---

**IMPORTANT:**

Never work with damaged equipment!

---

## 3.2 DIS Adapter Operation

For many engines equipped with a distributorless ignition system, the engine configuration information has been included in this manual. Refer to “Coil Information” on page 37.

**To perform tests with the DIS Adapter:**

1. Prepare the vehicle. Refer to “Preparing the Vehicle” on page 8
2. Establish the following engine data:
  - a. Ignition type
  - b. Number of cylinders
  - c. Firing order
  - d. Cylinder polarities
  - e. Cylinder pairs

Wasted Spark specific. A pair of cylinders are cylinders which are connected to the same coil directly.
  - f. Cylinder firing polarities

Wasted Spark specific. A cylinder pair consists of a negative firing polarity plug and a positive firing polarity plug. To determine the firing polarity. Refer to step 6. on page 8.

3. Connect the DIS Adapter to the MODIS Lab Scope Plug-in and engine ground.
4. Depending on the ignition type, use the following components:
  - Cable assembly dual pickup, for systems with coil or plug wires.
  - Quad adaptor lead with coil adaptors, for systems without coil or plug wires.
5. Select the proper view on the MODIS Lab Scope Plug-in.
6. Connect the relevant ignition components of all cylinders to the DIS Adapter leads.  
Connect one cylinder at a time. Depending on the ignition type, select a lead that is connected to the DIS Adapter, as follows:
  - Distributor—negative (–) connector
  - Wasted Spark—negative (–) and positive (+) connectors Refer to “Checking Firing Polarity” on page 14
  - Direct—negative (–) connector
7. Connect the trigger lead to cylinder number one, if possible.
8. Start the engine and check the ignition signals.

### 3.3 Preparing the Vehicle

Make sure you know what the result of the malfunction in the ignition system is. Some results may lead to engine or environmental damage.

If the following conditions are not met, engine damage may occur:

- The engine must have sufficient oil
- The engine coolant must be in good condition
- The engine must be at normal operating temperature.

### 3.4 Connecting to Coil and Plug Wires

#### WARNING

The engine compartment contains electrical connections and hot or moving parts.

- **Keep yourself, test leads, clothing and other objects clear of electrical connections and hot or moving engine parts.**
- **Do not wear watches, rings, or loose clothing when working in an engine compartment.**
- **Do not place equipment or tools on fenders or other places in the engine compartment.**
- **Barriers are recommended to help identify danger zones in test area.**

*Contact with electrical connections and hot or moving parts can cause injury.*

If the ignition system uses coil wires that can be accessed, proceed as follows:

1. Connect the cable assembly dual pickup to a negative (–) and/or positive (+) connector of the DIS Adapter. Polarity depends on the ignition type.
2. Connect the clamps to the relevant plug wires.

### 3.4.1 Connecting to Coils or Caps

If no secondary leads are present, use a pickup to receive secondary signals directly from the coil. There are two types of coil pickup:

- coil-specific pickups
- generic coil pickups

Contact your sales representative on the availability of pickups.

**Table 3-1** *Coil-specific pickups*

Term	Meaning	Application
COP	Coil-On-Plug	The coil is positioned on top of the plug, eliminating the need for a plug wire. Use a COP adaptor.
CIC	Coil-In-Cap	The coil is fitted inside the distributor cap. Use a CIC adaptor.

**Table 3-2** *Generic coil pickups*

Term	Meaning	Application
Flag	pickup that covers one coil at a time.	Use if no coil specific pickup is available.
Stick	pickup that picks up signal from more than one coil at a time. Can be used to detect signals from a cylinder bank or an ignition assembly (containing the coils and secondary leads in one housing per engine or cylinder bank.	Use if no coil specific pickup is available.

For some pickups, the phono adaptor provided with the kit may be needed.

### 3.4.2 Coil Pickups

It is preferred to use coil specific pickups. If these are not available, select a generic coil pickup.

#### Coil-Specific Pickups

These pickups are designed to fit on a specific coil. Due to their shape and clamping facility, there is an optimal match between the pickup and coil under test.



**Figure 3-1** *Sample specific-coil pickup*



For an overview, refer to “Coil Adapters” on page 29.

## Generic pickups

Two types of generic pickups are available:

- flag
- stick.

These pickups are directional with sides marked “A” and “B”.

- To increase the signal, let side “A” face towards the coil.
- To decrease the signal, let side “B” face towards the coil.

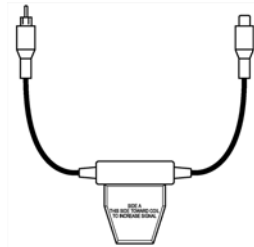

**Figure 3-2** *Sample single flag pickup*

These pickups can be coupled onto each other. Position these pickups next to the coil.

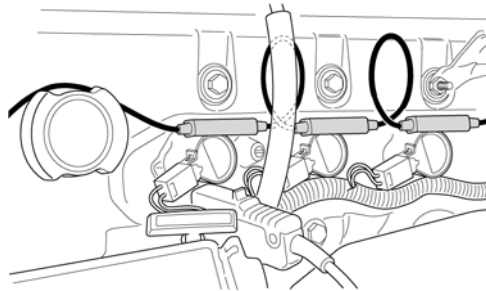

**Figure 3-3** *Flag pickup positioning*



---

**NOTE:**

Several clips can be connected to each other with only one of them being connected to the quad adaptor lead

---



**Figure 3-4** *Sample stick pickup*

Position stick pickups across the tops of a bank of coils.

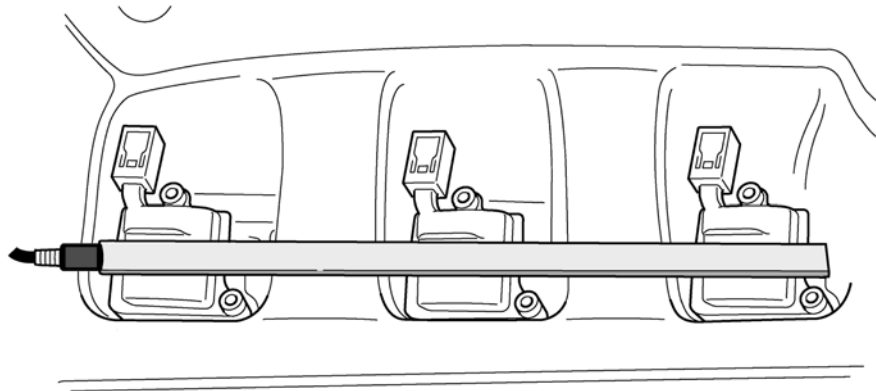

**Figure 3-5** Sample stick pickup positioning

### **Selecting a generic pickup**

The pickups to use depend mainly on the physical location and design of the coils.

- “Stick” pickups work well if the coils are in a line without any other components between them and have a flat surface the pickup can rest against. They have the advantage of being easier to keep in the same relationship to each coil because of their shape.
- “Flag” pickups work on coils having a laminated core that extends outside of the housing. Try inserting the “Flag” pickup between the housing and the laminated core. Flag pickups also work on many vehicles where the coil is located in a recess in the valve cover or located in a place that allows the flag to sit next to the coil.

Because of their greater surface area, the flags may be able to pick up a weaker signal on some coils depending on the shape and/or location of the coil windings. If the signal is weak with the sticks, try the flags.

### **Pickup sensitivity**

The pickups are double sided. The strength of the coil signal detected by the pickup depends on the side of the pickup facing the coil.

One side has a signal plane that detects the pattern from the coil, and the other side has a ground plane that helps minimize unwanted signals.

- If the side with the ground plane is facing the coil (labelled “Side B – This side toward coil to reduce signal”), the signal will be weaker. It has to pass the ground plane to reach the signal plane.
- If the side with the signal plane is facing the coil (labelled “Side A – This side toward coil to increase signal”), the signal will be stronger. It goes directly to the signal plane without having to pass through the ground plane.
- The outer edges of the pickup extends about 1/16 inch past the edge of the signal and ground planes. This prevents them from being shorted to a vehicle component or surface along this edge.
- The flat surfaces of the pickups have a thin coating that prevents them from shorting to the vehicle. In the event a pickup is scratched and shorts to the vehicle, the surface can be repaired with any coating that covers the scratch and does not interfere with their fit to the vehicle.

### Positioning Generic Pickups

On an unfamiliar vehicle, you will have to experiment to find the best location for the pickup. The easiest way to do this is by experimenting on a coil. Use the Single Cylinder scope and set the trigger level low to begin with (1-2 kV and 25-50 ms is a good place to start).



#### To position a generic pickup:

1. Start with "Side B" towards the coil.

This places the pickup with the ground plane facing or nearest to the coil. With the ground plane facing the coil, weaker unwanted signals are not strong enough to make it past the ground plane. The secondary signal is typically strong enough to use the pickup in this manner.
2. Move the pickup around the coil and see where the signal is the strongest and looks the best. You may need to increase the scope trigger level depending on the signal strength for best viewing.

As you move the pickup around the coil, you may see the shape of the pattern change. This is likely due to the location of the secondary and primary windings inside of the coil. The pattern tends to portray the windings closest to the pickup.
3. If the signal level is not strong enough, try Side A facing the coil. This places the signal plane closest to the coil giving the strongest signal.



---

**NOTE:**

On some coils, the pattern looks like a conventional secondary pattern. On others, there may be much less detail.

---



---

**NOTE:**

On some coils you will note a large difference in the pattern depending on the exact location of the pickup in relation to the coil. Pick the spot that gives the best pattern and allows the pickup to "stay put" (otherwise improvise to hold the pickup in the desired place).

---



---

**NOTE:**

Each pickup should be located in the same position on each coil, so the signal is the same from each one.

---

### 3.4.3 Connecting to Ignition Systems

Always proceed in the following order:

1. Determine the required vehicle information. Refer to "Preparing the Vehicle" on page 8
2. Connect the relevant ignition components that are to be connected to the DIS Adapter.
3. Connect the trigger clamp to cylinder #1 if applicable.
4. Adjust the application settings, if required.

A wide variety of ignition systems and configurations is available on the market. Some systems allow for more than one way of obtaining an ignition signal.

The following list may not contain all possible ignition system configurations, due to constant improvement of the automotive technology.

## Distributor

This section describes ignition systems that use one or more distributors.

### *Conventional Ignition Systems*

These systems have an external coil, a high tension lead, a distributor and plug wires.



#### To connect a conventional system:

1. Connect one or more cable assembly dual pickups to a negative (-) connector of the DIS Adapter
2. Connect a pickup to the coil wire.

### *Distributor with Coil-in-Cap*

These systems have the coil integrated in the distributor cap and have secondary leads.



#### To connect a coil-in-cap system:

1. Connect the quad adaptor lead to a negative (-) connector of the DIS Adapter
2. Place a CIC pickup on the cap.
3. Connect the CIC pickup to the quad adaptor lead.

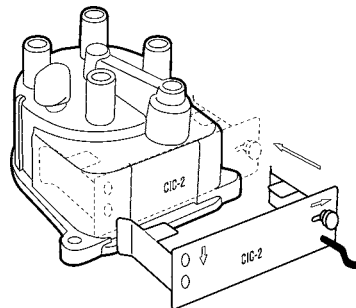

**Figure 3-6** Sample coil-in-cap pickup

## Wasted Spark Ignition

These ignition systems have one coil connected to every 2 spark plugs. These spark plugs are not placed in the same cylinder:

- one plug fires in what is the ignition stroke with a 4-stroke engine. During that stroke the compressed air/fuel mixture will be ignited and will expand.
- one plug fires during the exhaust stroke.

One plug fires from the center electrode to the ground electrode (negative), the companion plug fires from the ground electrode to the center electrode (positive). Various setups are possible:

- two secondary leads connecting the coil to the plugs.
- one secondary lead plus a Direct Coil setup.

**To test wasted spark ignition systems:**

1. Connect an appropriate adaptor (cable assembly dual pickup or a coil specific pickup via the quad adaptor lead) to a cylinder and connect it to the DIS Adapter. Refer to “Checking Firing Polarity” on page 14.
2. Connect an appropriate adaptor, from another Assembly or Lead (cable assembly dual pickup or a coil specific pickup via the quad adaptor lead) to the companion of the cylinder mentioned before. Now connect the other Assembly or Lead to a connector of the DIS Adapter with a different polarity.
3. Repeat previous steps to connect all plugs.

**NOTE:**

Always check the polarity. Different engines may have a different setup.

**Checking Firing Polarity**

Only with wasted spark ignition systems, positive and negative firing polarities are possible.

**To determine the firing polarity:**

1. Connect the DIS Adapter to the MODIS Lab Scope Plug-in and a good vehicle ground.
2. Connect one set of dual pickups to the negative (–) connector on the DIS Adapter.
3. Select the Ignition Scope in single cylinder mode.
4. Connect the pickup to a plug wire. A negative firing cylinder displays normally (positive direction of the Y-axis). A positive firing cylinder displays upside down.

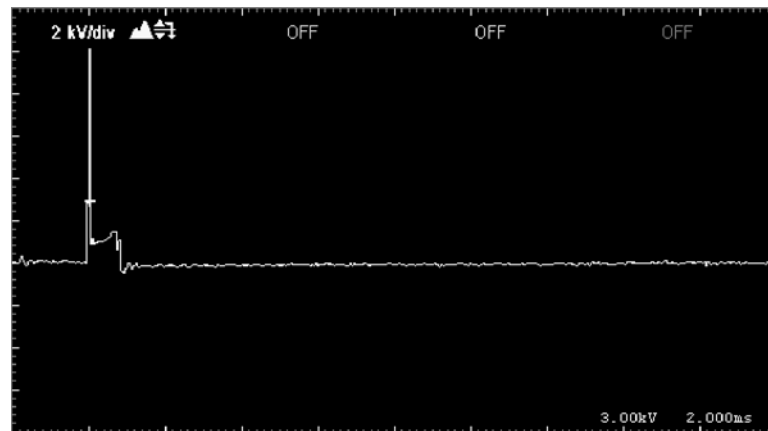

**Figure 3-7** Negative firing cylinder, displayed normally

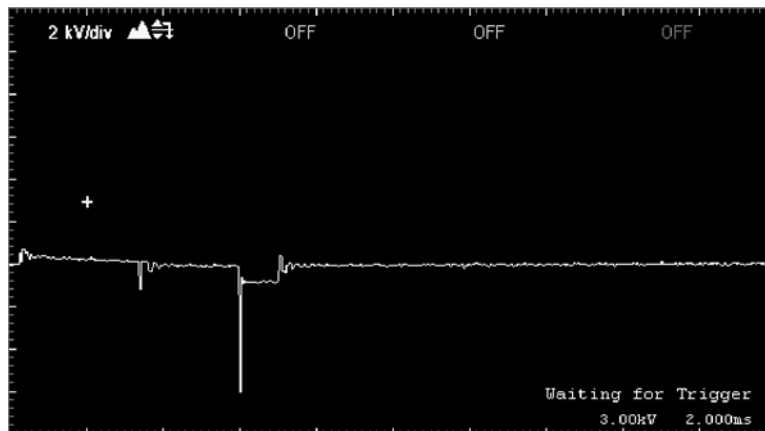

**Figure 3-8** Positive firing, kV line in normal setup

5. Note the cylinder polarity. The companion plug has an opposite firing polarity. Repeat the process on each cylinder. Half the amount of cylinders is positive, half the amount is negative.
6. Enter the correct cylinder firing polarity into the ignition setup along with the other required information.
7. Connect the cable assembly dual pickup to the negative (–) and positive (+) connectors of the DIS Adapter. Connect the pickups to the relevant cylinders.

### **Wasted Spark with Direct Coil (Hybrid Ignition System)**

For a typical example of a combination of direct coil and wasted spark:

- Two pickups are mounted directly on top of the coils.
- Two high tension wires are connected to the companion spark plugs.



- 1— Two flag pickups plus a quad adaptor lead assembly**  
**2— One cable assembly dual pickup is required**

**Figure 3-9** Direct ignition/wasted spark pickup positioning sample

**NOTE:**

Not every hybrid ignition system supplies good, clear signals easily. The location of the generic pickup in the figure is an example of one possible location for the pickup. You may need to make several attempts. Refer to “Positioning Generic Pickups” on page 12.

**NOTE:**

Sometimes it is not possible to pick up the ignition pattern from the cylinder of which only the coil is accessible. If that happens, insert a plug wire between the coil and the plug. The ignition system can then be tested like a standard wasted spark ignition system with 2 wires on each coil.

## Direct Ignition Systems

Direct ignition systems use one coil for every spark plug. The coil may be mounted directly onto the spark plug, thus eliminating the plug wire. Or the coil may be remotely mounted from the spark plug, requiring a plug wire.

Another setup is a distributorless ignition system with plug wires positioned in an ignition assembly that is not supposed to be opened. Such an assembly is fitted directly on top of the plugs.

To test, connect a coil specific pickup (preferred) or a generic pickup via the quad adaptor lead to a negative (–) connector of the DIS Adapter.

### *Direct Ignition Systems without Plug Wires*

For these systems, each coil has its own specific pickup mounted directly to the coil.

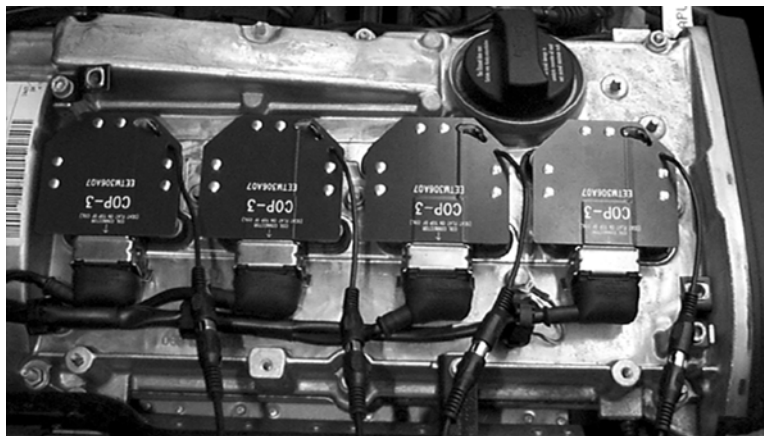

**Figure 3-10** *Direct ignition pickup positioning sample*

### *Direct Ignition Systems with Plug Wires*

**To test direct ignition systems with plug wires:**

1. Connect the cable assembly dual pickup to a negative (–) connector of the DIS Adapter.
2. Connect one pickup to each plug wire.

After preparing the vehicle, DIS Adapter and the MODIS Lab Scope Plug-in for operation, the ignition waveforms should appear on the screen. Due to a variety of technologies and constructions used by vehicle manufacturers and after market suppliers, experience with testing on “good” and “bad” ignition systems will give the operator better insight and confidence in the interpretation of test results.

## 4.1 Interpreting test results

A secondary ignition waveform appears on the screen.

- Waveforms collected with the DIS Adapter can be analyzed like all other conventional secondary ignition waveforms.
  - The higher the spark voltage, the shorter the duration; the lower the spark voltage, the longer the duration.
  - Relative measurements are more important than absolute values. Compare cylinders to each other and look for noticeable differences.
- The “Firing kV” values on Direct Ignition and Wasted Spark ignition systems may vary more than on conventional distributor systems. This variation, in itself, does not indicate a problem. Examine both the spark voltage and burn time (duration).
- Many coils have diodes in the secondary circuit and the secondary resistance of these coils can not be measured. Refer to manufacturer specifications for information about these coils.
- Coil oscillations on coil-on-plug systems may be lower than coil oscillations of previous (‘conventional’) systems. In some cases normal oscillations may be as low as zero. Compare each vehicle coil with others on the vehicle to identify a coil with a different characteristic.
- Check the spark line on all cylinders. Suspect any that are smooth, less turbulent, or with a different slope. Sparks that occur outside the combustion chamber are typically more stable than sparks that occur in the combustion chamber.

## 4.2 Troubleshooting

This section addresses common problems with triggering and unstable patterns that may occur when testing with the DIS Adapter.

For problems at any engine speed, including cranking:

- Check all lead connections.
- Check for correct positioning of all pickups.
  - Pickups must contact each coil identically for consistent test results.
  - Generic pickups are directional with sides marked “A” and “B”. Turn over the pickup to change the sensitivity.
- Check all tester ground connections.



**NOTE:**

Because spark duration and voltage are related, any system problem that affects one, affects the other as well.

- If spark voltage increases, spark duration decreases.
- If spark voltage decreases, spark duration increases.

## 4.2.1 Polarity Issues

Most of the vehicles have a negative firing setup. Plugs fire from the center electrode to the side or ground electrode.

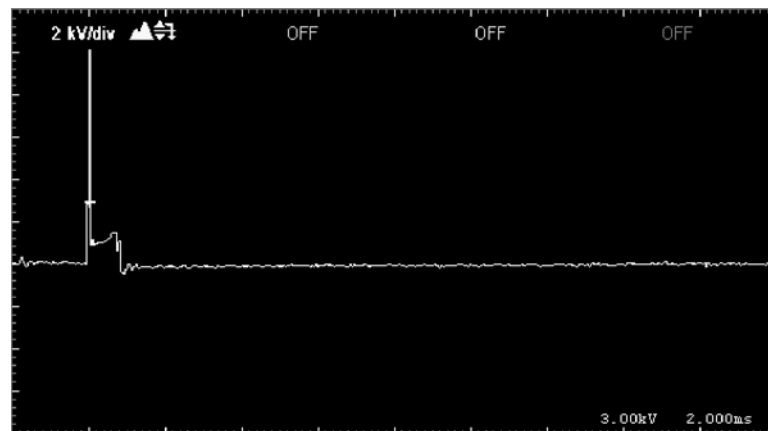

**Figure 4-1** Negative firing. kV line in normal setup

With a positive firing setup, the plug fires from the side or ground electrode to the center electrode.

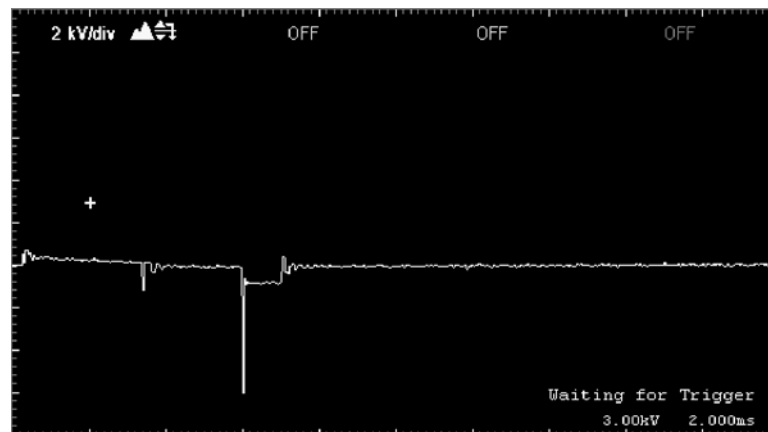

**Figure 4-2** Positive firing. kV line in normal setup

Refer to “DIS Adapter Operation” on page 7 for more information.

## 4.2.2 Wasted Spark Systems

This section gives an example of a “good” wasted spark system pattern and several “faulty” system patterns with explanations.

### Normal Pattern

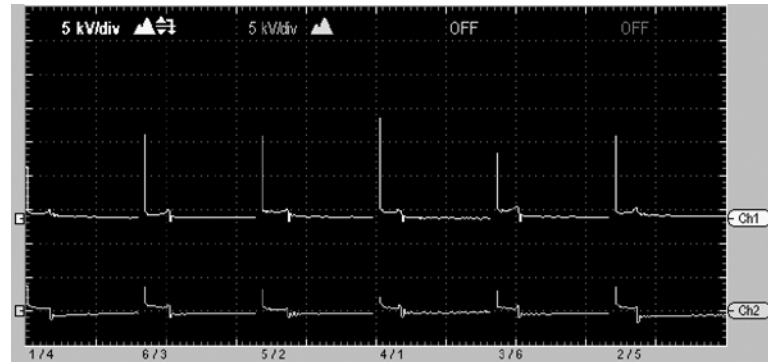

Figure 4-3 Normal pattern

All settings and connections are correct. Power firings are on channel 1. The wasted spark firings are on channel 2.

## 4.2.3 Synchronization

The following sequence of illustrations shows what happens when the scope synchronizes to cylinder number one. This is normal and may happen when the scope is entered, the engine is started, or a scope setting is changed. After a few screens the pattern stabilizes when synchronization to cylinder number one is established.

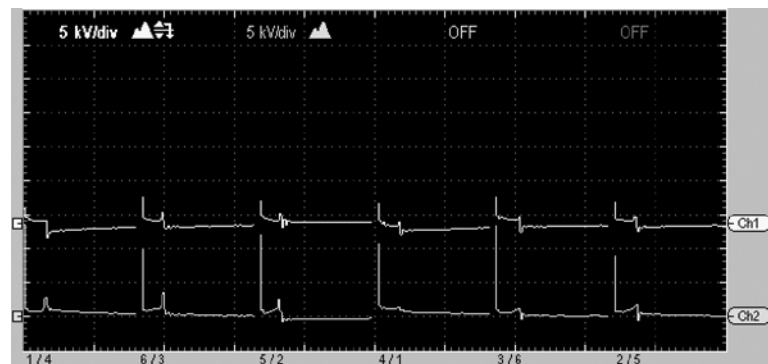
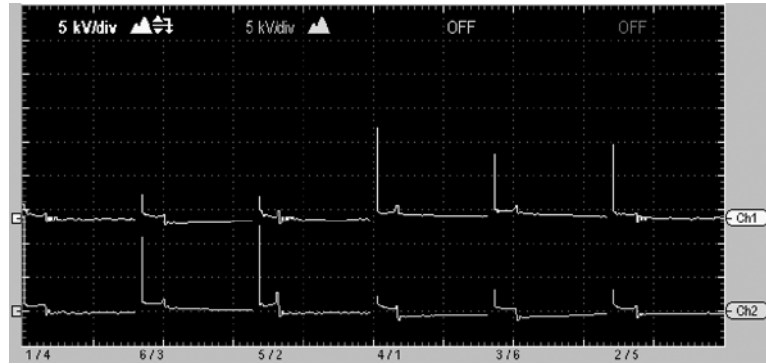

Figure 4-4 Synchronization in process



**Figure 4-5** Synchronization in process



**Figure 4-6** Synchronization complete, pattern stabilized

### 4.2.4 Inverted Signal

The following illustration shows an example of an inverted, or upside down, signal trace.

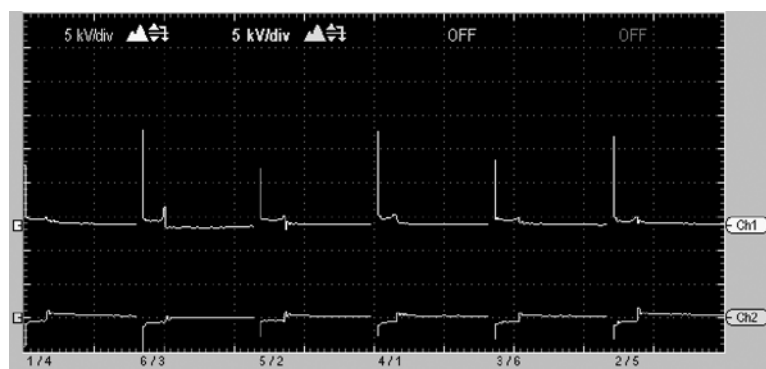
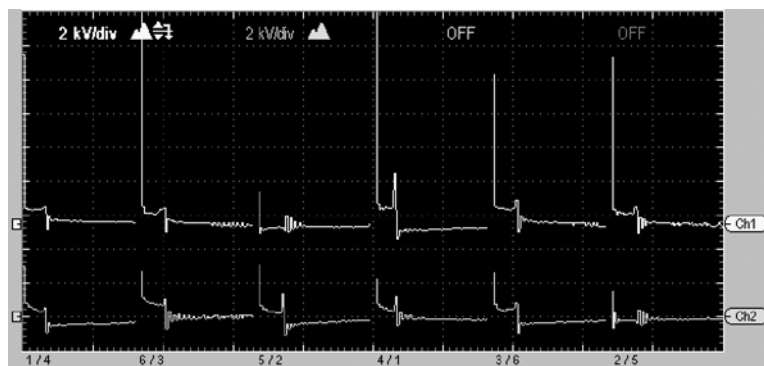

**Figure 4-7** Inverted trace on channel 2

For wasted spark ignition testing, the channel 1 signal should be inverted (spike going down) and channel 2 should not be inverted (spike going up).

## 4.2.5 Pickup Not Connected to a Cylinder

The trace in the following illustration is the result of the plug wire for cylinder five not being connected to a pickup.



**Figure 4-8** *Cylinder five signal missing*

The small spike in kV that is present is due to noise from cylinder five being induced in one or more of the other plug wires that are connected to a pickup.

It should be noted that the pattern may be rolling or not correctly synchronized to cylinder one in the following situations:

- Pickup not connected to a cylinder
- Incorrect ignition setup
- Reversed measuring leads.

## 4.2.6 Incorrect polarity setup

The following illustration is an example of an incorrect polarity setup.

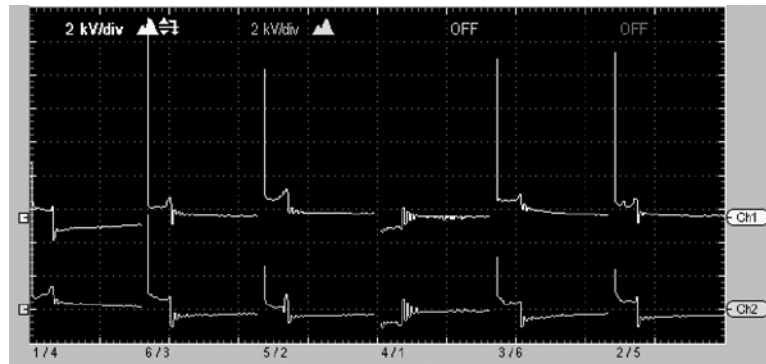

**Figure 4-9** *Incorrect polarity setup*

The positive and negative pickups are connected to the correct plug wires, but the correct polarity is not entered into the ignition setup. The result is that the power and wasted firings are mixed up on the cylinders where the firing polarity is incorrect. Cylinders two and five in this case.

## 4.2.7 Reversed Measuring Leads

The following illustration shows a sample trace created when the leads are reversed.



**Figure 4-10** Reversed negative (-) and positive (+) connections

The positive and negative leads are reversed on one ignition coil. The affected cylinders appears upside down.

The DIS Adapter does not require any specific maintenance services. However, the following should be performed to keep the unit in good working order:

- Prior to and after each use, check the housing, wiring and connectors for dirt and damage.
- Clean the housing, wiring and connectors with a damp cloth at the end of each working day.

## **5.1 Disposal of the DIS Adapter**

Always recycle and dispose of materials according to local regulations. Contact your Sales Representative for details.



# Ignition Waveforms

Ignition waveforms have three basic sections. An ignition event begins with a firing line at the left of the screen, continues through the intermediate and dwell sections, and ends with the beginning of another firing line at the right edge of the screen.

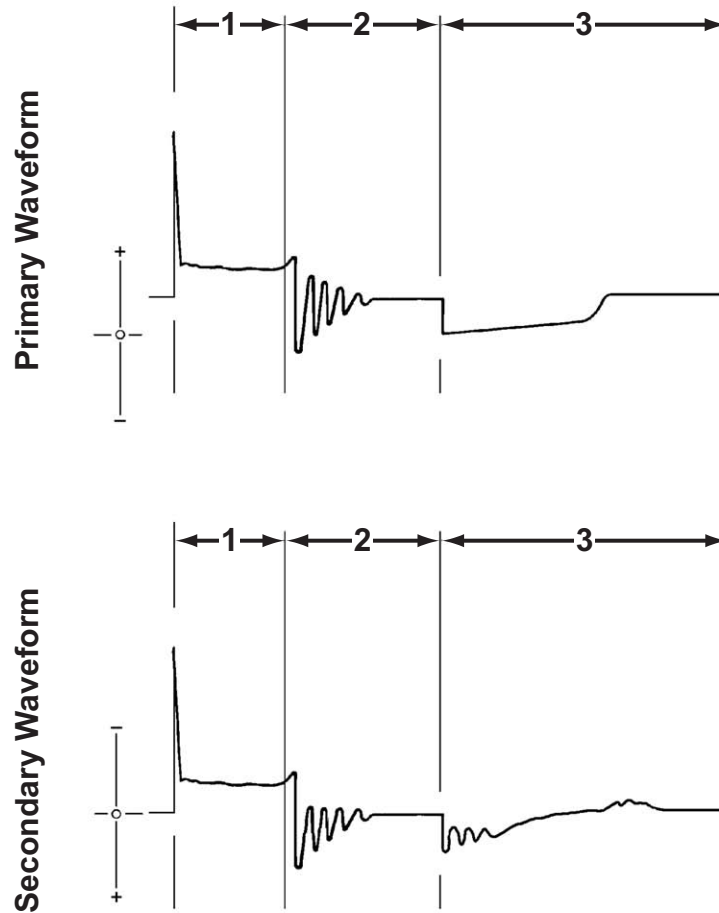

- 1— Firing section
- 2— Intermediate section
- 3— Dwell section

**Figure A-1** *Sample ignition waveform*



## A.1 The Ignition Cycle

Waveforms have specific points that show important information when checking an ignition system. A complete ignition cycle of a cylinder runs from primary current switching on to the next primary current on event. Therefore, the description and explanation of the waveforms begins just before primary current switches on.

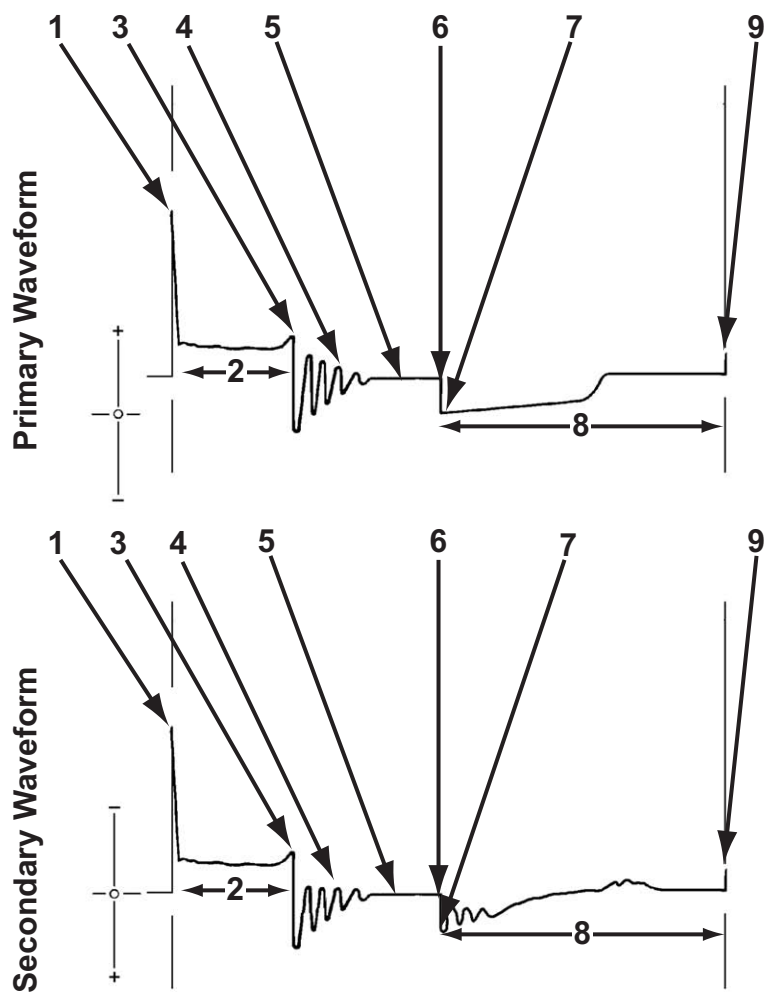

- 1— Start of ignition
- 2— Spark line
- 3— End of ignition
- 4— Coil oscillations
- 5— No current in the primary coil
- 6— Primary current turns on
- 7— Start of primary current
- 8— Current limiting
- 9— Primary current turns off

Figure A-2 Sample ignition cycle

## Start of Ignition

High voltage is induced, by mutual induction, into the secondary winding because of the primary to secondary turns ratio. The secondary voltage overcomes the resistance in the secondary circuit up to the spark plug gap. The spark plug gap is ionized and current arcs across the electrodes to produce the spark that initiates combustion.

## Spark Line

Voltage is reduced to about 1/100th of the secondary voltage, because of the 100:1 step-down ratio. This is the actual discharge across the air gap between the spark plug electrodes.

## End of Ignition

The coil energy is no longer able to sustain the spark across the electrodes at this point.

## Coil Oscillations

An oscillating voltage results (in step with the secondary voltage) because of the step-down ratio as current dissipates in the primary circuit.

## No Current in the Primary Coil

The trace flattens out when there is no longer current in the primary ignition circuit. Battery or charging system voltage available at this point is about 12 to 15 volts.

## Primary Current Turns On

The primary circuit switching device switches on the primary current. This starts the dwell period.

## Start of Primary Current

Current in the primary circuit establishes a magnetic field in the ignition coil windings. The strength of the field builds during the dwell period.

## Current Limiting

This represents the dwell period or “on-time” of the ignition coil primary current:

- The rise in voltage (primary waveform) indicates that current limiting is occurring.
- On ignition systems that use current limiting to control the coil current, a current hump or voltage ripple appears on the “on-time” portion of the primary waveform during the dwell section.

## Primary Current Turns Off

The primary switching device stops the primary current flow suddenly. The magnetic field that had built up collapses. This induces a high voltage in the primary winding by self-induction.

This section shows an overview of adapters that are available for testing distributorless ignition systems. Contact your sales representative for additional information. There are two types of coil adapters:

- Coil-in-cap (CIC)
- Coil-on-plug (COP)

## B.1 Coil-in-cap Adapters

Coil-in-cap (CIC) adapters are used for testing systems that have a conventional distributor with the ignition coil integrated into the distributor cap.

### CIC-1

The CIC-1 (part number EETM306A06) fits General Motors HEI coil-in-cap systems. This adapter works on caps with or without a plug wire retainer ring. Use the thumbscrew to reposition the clip for the cap configuration being tested.

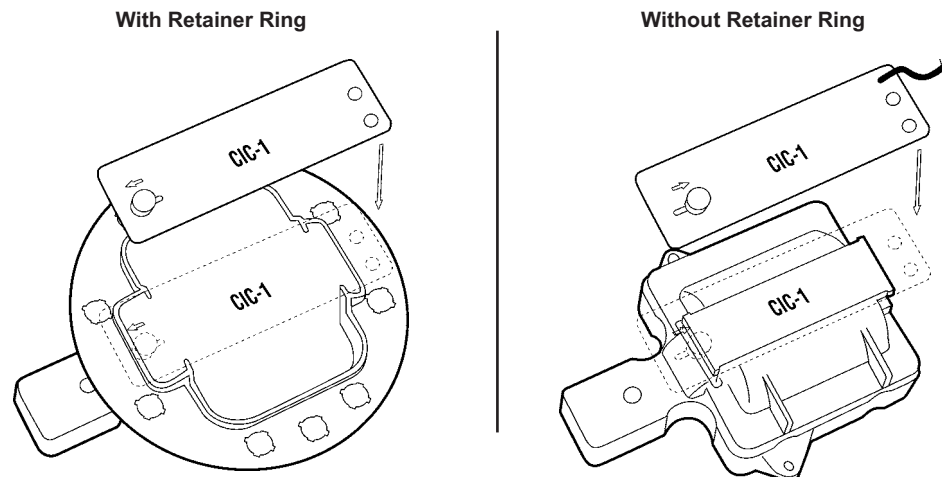

**Figure B-1** Sample CIC-1 installation

## CIC-2

The CIC-2 (part number EETM306A05) fits most Toyota and Honda models with coil-in-cap systems. One of the side clips is thumbscrew adjustable to accommodate different size caps.

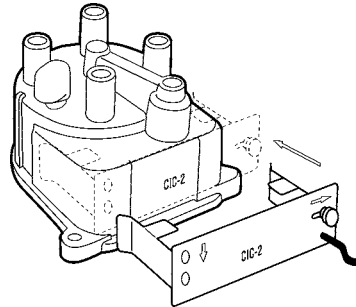

**Figure B-2** Sample CIC-2 installation

## B.2 Coil-on-plug Adapters

Coil-on-plug (COP) adapters are for testing ignition coils that mount directly to a spark plug.

### COP-1

The COP-1 (part number EETM306A03) fits Ford, Lincoln, and Mercury vehicles.

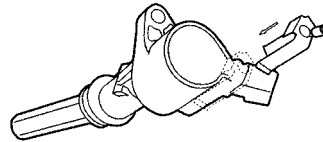

**Figure B-3** Sample COP-1 installation

The COP-1 can be used on the following models:

- Ford:
  - 1996–2000 Taurus SHO with 3.4L
  - 1996–2006 E-Series and F-Series with 5.4L or 6.8L
  - 1998–2006 Crown Victoria with 4.6L
  - 1999–2006 Mustang with 4.6L
  - 2000–2006 F-Series with 4.6L
  - 2001 Escape with 2.0L ZTEC
  - 2001–03 Escort with 2.0L
  - 2001–04 Expedition with 4.6L
  - 2001–05 Excursion with 5.4L or 6.8L
  - 2001–06 E-Series with 4.6L, Escape with 3.0L, and Expedition with 5.4L

- 2002–06 Explorer with 4.6L
- 2003 Explorer Sport with 4.6L
- 2003–06 Focus with 2.0L or 2.3L and Taurus with 3.0L DOHC
- 2005–06 Escape with 2.3L, Five Hundred and Freestyle with 3.0L, and Ford GT with 5.4L
- 2006 E-Series and F-Series with 6.0L and Fusion with 2.3L or 3.0L
- 2007 Edge with 3.5L
- Lincoln
  - 1998 Mark VII with 4.6L
  - 1998–2004 Town Car
  - 2001–02 Continental with 4.6L
  - 2001–03 LS with 3.9L
  - 2001–05 LS with 3.0L
  - 2001–06 Navigator with 5.4L
  - 2002 Blackwood with 5.4L
  - 2003–05 Aviator with 4.6L
  - 2006 Mark LT with 5.4L and Zephyr with 3.0L
- Mercury
  - 1998–2006 Grand Marquis with 4.6L
  - 2002–06 Mountaineer with 4.6L
  - 2003–05 Sable with 3.0L DOHC
  - 2004 Marauder with 4.6L
  - 2005–06 Mariner with 2.3L or 3.0L and Montego with 3.0L
  - 2006 Milan with 2.3L or 3.0L

## COP-2

The COP-2 (part number EETM306A04) fits Chrysler, Dodge, and Plymouth vehicles.

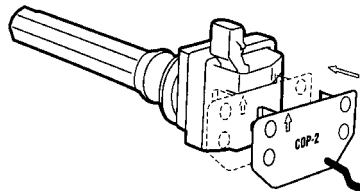

**Figure B-4** *Sample COP-2 installation*

The COP-2 can be used on the following models:

- Chrysler:
  - 1998–99 300, Concorde, and LHS with 3.2L
  - 1998–2002 LHS with 2.7L or 3.5L
  - 1998–2004 Concord with 2.7L or 3.5L
  - 1998–2006 300 with 2.7L or 3.5L
  - 2005–06 Pacifica with 3.5L

- Dodge:
  - 1998–99 Intrepid with 3.2L
  - 1998–2004 Intrepid with 2.7L or 3.5L
  - 2003–06 Sebring and Stratus with 2.7L
  - 2005 Sebring and Stratus with 3.0L
- Plymouth: 1998–2000 Prowler 3.5L

## COP-3

The COP-3 (part number EETM306A07) fits Volkswagen and Audi vehicles

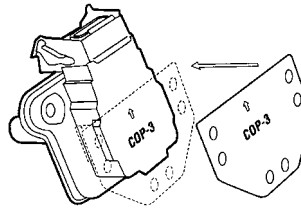

**Figure B-5** Sample COP-3 installation

The COP-3 can be used on the following models:

- 1998–1999 VW Passat with 1.8L Turbo
- 1997–1999 Audi A4 with 1.8L Turbo
- 1997–1999 Audi A8 with 4.2L

## COP-4

The COP-4 (part number EETM306A08) fits Acura, Honda, and Isuzu vehicles.

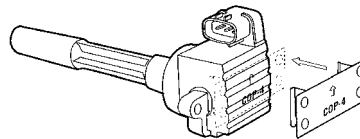

**Figure B-6** Sample COP-4 installation

The COP-4 can be used on the following models:

- Acura:
  - 1991–2006 NSX
  - 1996–1999 SLX
- Honda: 1996–1999 Passport
- Isuzu:
  - 1996–1997 Trooper 3.2L
  - 1997–1999 Rodeo
  - 1998–1999 Amigo and Trooper 3.5L

## COP-5

The COP-5 (part number EETM306A09) fits BMW, Infiniti, Jaguar, Land Rover, Nissan and Volvo vehicles.

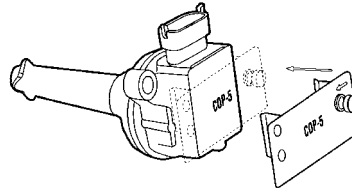

**Figure B-7** Sample COP-5 installation

The COP-5 can be used on the following models:

- BMW:
  - All with Bremi 11-860 series coils
  - All with Beru 0040100002 series coils
  - All with Bosch 0221504004 series coils
- Infiniti:
  - 2001 QX4
  - 2003–05 FX35
  - 2004–05 QX56
  - 2005 G35, FX45, and QX45
- Jaguar: 1997 XK8
- Land Rover: 2003–04 Range Rover
- Nissan:
  - 2000–06 Pathfinder and Sentra 1.8L
  - 2002–06 Altima, Maxima, and Sentra 2.5L
  - 2003–06 350Z and Murano
  - 2004–06 Titan
  - 2005 Armada, Frontier, and Quest
- Volvo:
  - 1992–1997 Volvo 960
  - 1998 Volvo S90 and V90
  - 1999–2000 S70
  - 1999–2006 C70, V70, and S80
  - 2000–03 V40
  - 2000–06 S40
  - 2001–06 S60
  - 2003–06 XC70 and EX90 (except V8 models)
  - 2005–06 V50



## COP-6

The COP-6 (part number EETM306A10) fits Mercedes-Benz vehicles.

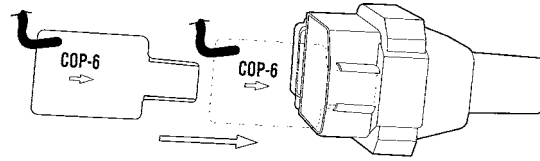

**Figure B-8** *Sample COP-6 installation*

The COP-6 can be used on the following models:

- 1996–1999 S600, SL600, and CL600 with M120 engine
- 1996–1997 E420, S420, S500, and SL500 with M119 engine

## COP-7

The COP-7 (part number EETM306A11) fits Mercedes-Benz vehicles.

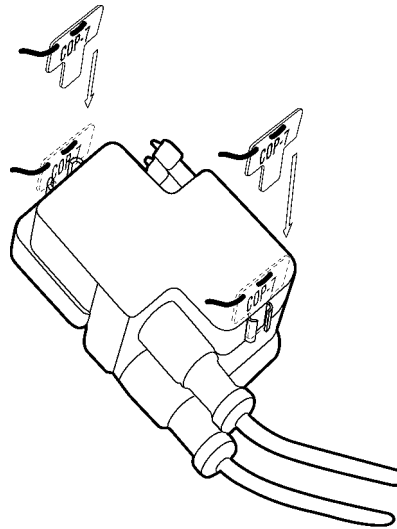

**Figure B-9** *Sample COP-7 installation*

The COP-7 can be used on the following models:

- 1998–2006 All models with M112 and M113 engines

## COP-8

The COP-8 (part number EETM306A12) fits BMW vehicles.

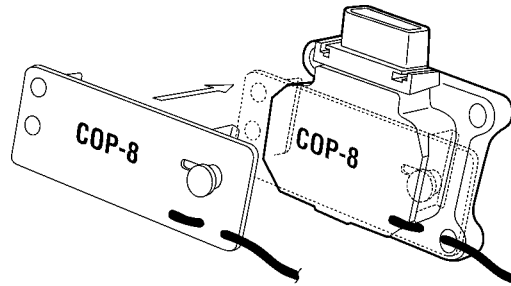

**Figure B-10** Sample COP-8 installation

The COP-8 can be used on the following models:

- All models with Bremi 11-852 and 11-856 series coils
- All models with Zundspule coils

## COP-9

The COP-9 (part number EETM306A13) fits Lexus and Toyota vehicles.

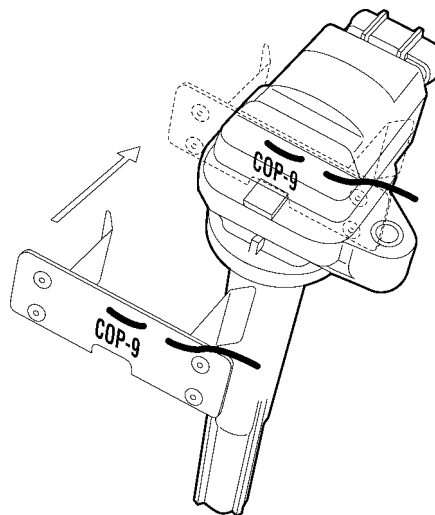

**Figure B-11** Sample COP-9 installation

The COP-9 can be used on the following models:

- 1998–2001 GS400 with 1UZ-FE engine
- 1998–2001 LS400 with 1UZ-FE engine
- 1998–2001 LX470 with 2UZ-FE engine
- 2002–04 Camry with 1MZ-FE engine
- All other models equipped with Lexus coil part number 90919-02228

## COP-11

The COP-11 (part number EETM306A14) fits Chrysler, Jeep, Lexus, and Toyota vehicles.

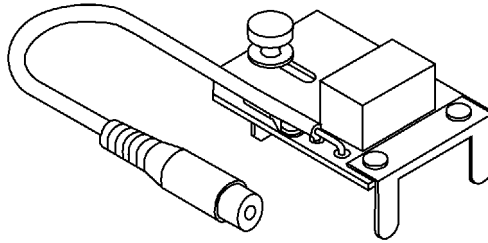

**Figure B-12** *Sample COP-11 installation*

The COP-11 can be used on the following models:

- Chrysler:
  - 2000–03 Dakota and Durango 4.7L
  - 2003 Dodge Ram 3.7L
- Jeep:
  - 1999–2003 Grand Cherokee 4.7L
  - 2002–03 Liberty and Renegade 3.7L
- Lexus:
  - 1999–2002 ES300 RX300 3.0L 24V
  - 2001–02 GS430 and LS 430
- Toyota:
  - 1998–2002 Corolla 1.8L and Landcruiser 4.7L
  - 2000 Tacoma 2.7L and California 2.4L
  - 2000–01 Sienna
  - 2000–02 Avalon, Celica GT, Celica GTS, Echo, MR2, and Tundra
  - 2001–02 Highlander, Prius, RAV4, Sequoia, and Tacoma 2.4L and 2.7L
  - 2002 Camry 2.4L

# Coil Information

This section contains information that is required to connect the DIS Adapter to the coils. This information may not cover all vehicles on the market.

The information is grouped per manufacturer. If a field is blank, it may indicate that the engine data is valid for all engines that apply to the engine data that is shown in other fields. Or it might mean that specific exceptions are not known.

**Table C-1** Engine data overview

Make	Cyl.	Size	VIN	Info
Acura	6			<p>The diagram shows a 6-cylinder engine layout. Cylinders 1, 2, and 3 are on the left side, and cylinders 4, 5, and 6 are on the right side. The front of the engine and vehicle is indicated by downward arrows. A box on the right contains the text: 'HONDA / ACURA V6 COIL PER CYLINDER', 'FIRING ORDER 1-4-2-5-3-6', 'CYLINDER POLARITY' (with a dot symbol), and 'IGNITION COIL' (with a dot symbol).</p>
Audi	4	all		<p>The diagram shows a 4-cylinder engine layout. Cylinders 1, 2, 3, and 4 are arranged vertically. The front of the engine and vehicle is indicated by downward arrows. A box on the right contains the text: 'AUDI / VOLKSWAGEN ALL 4 CYLINDER COIL PER CYLINDER', 'FIRING ORDER 1-3-4-2', and 'IGNITION COIL' (with a dot symbol).</p>
Audi	5	all		<p>The diagram shows a 5-cylinder engine layout. Cylinders 1, 2, 3, 4, and 5 are arranged vertically. The front of the engine and vehicle is indicated by downward arrows. A box on the right contains the text: 'AUDI ALL 5 CYLINDER', 'FIRING ORDER 1-2-4-5-3', and 'IGNITION COIL' (with a dot symbol).</p>

# Coil Information

**Table C-1** Engine data overview

Make	Cyl.	Size	VIN	Info
Audi	6	2.8L		<p>AUDI V6 2.8 LITER</p> <p>CYLINDER PAIRS 1-6 4-2 3-5</p> <p>FIRING ORDER 1-4-3-6-2-5</p> <p>CYLINDER POLARITY</p> <p>FRONT OF ENGINE FRONT OF VEHICLE</p>
Audi	6	2.8L		<p>AUDI / VW V6 2.8 LITER LONGITUDINAL</p> <p>CYLINDER PAIRS 1-6 4-2 3-5</p> <p>FIRING ORDER 1-4-3-6-2-5</p> <p>CYLINDER POLARITY</p> <p>FRONT OF ENGINE FRONT OF VEHICLE</p>
Audi	6	2.8L		<p>AUDI / VW V6 2.8 LITER TRANSVERSE</p> <p>CYLINDER PAIRS 1-6 5-2 3-4</p> <p>FIRING ORDER 1-5-3-6-2-4</p> <p>CYLINDER POLARITY</p> <p>FRONT OF VEHICLE</p>
Audi	8			<p>AUDI V8 COIL PER CYLINDER</p> <p>FIRING ORDER 1 5 4 8 6 3 7 2</p> <p>IGNITION COIL</p> <p>FRONT OF ENGINE FRONT OF VEHICLE</p>
Audi	8			<p>AUDI V8 COIL PER CYLINDER</p> <p>FIRING ORDER 1 5 4 8 6 3 7 2</p> <p>IGNITION COIL</p> <p>FRONT OF ENGINE FRONT OF VEHICLE</p>

**Coil Information**

**Table C-1** Engine data overview

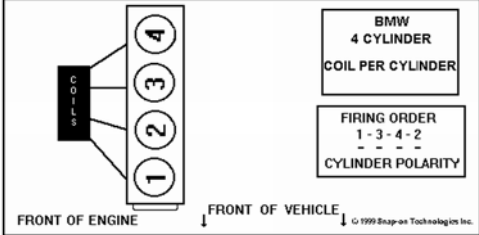
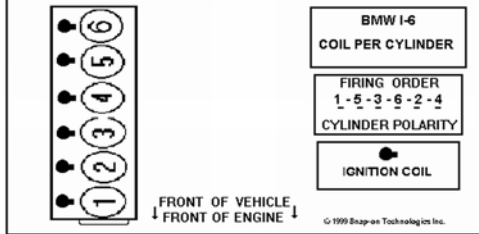
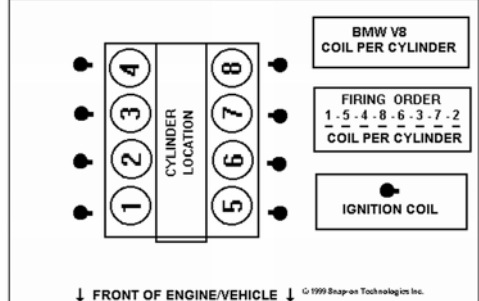
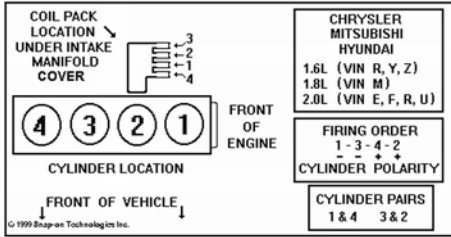
Make	Cyl.	Size	VIN	Info
BMW	4			 <p>BMW 4 CYLINDER COIL PER CYLINDER</p> <p>FIRING ORDER 1 - 3 - 4 - 2 CYLINDER POLARITY</p>
BMW	6			 <p>BMW I-6 COIL PER CYLINDER</p> <p>FIRING ORDER 1 - 5 - 3 - 6 - 2 - 4 CYLINDER POLARITY</p> <p>IGNITION COIL</p>
BMW	8			 <p>BMW V8 COIL PER CYLINDER</p> <p>FIRING ORDER 1 - 5 - 4 - 8 - 6 - 3 - 7 - 2 COIL PER CYLINDER</p> <p>IGNITION COIL</p>
Chrysler	4	1.6L	R, Y, Z	 <p>COIL PACK LOCATION UNDER INTAKE MANIFOLD COVER</p> <p>FRONT OF ENGINE</p> <p>FRONT OF VEHICLE</p> <p>CHRYSLER MITSUBISHI HYUNDAI 1.6L (VIN R, Y, Z) 1.8L (VIN M) 2.0L (VIN E, F, R, U)</p> <p>FIRING ORDER 1 - 3 - 4 - 2 CYLINDER POLARITY</p> <p>CYLINDER PAIRS 1 &amp; 4    3 &amp; 2</p>

# Coil Information

**Table C-1** Engine data overview

Make	Cyl.	Size	VIN	Info
Chrysler	4	1.8L	M	<p>COIL PACK LOCATION UNDER INTAKE MANIFOLD COVER</p> <p>FRONT OF ENGINE</p> <p>CYLINDER LOCATION</p> <p>FRONT OF VEHICLE</p> <p>CHRYSLER MITSUBISHI HYUNDAI 1.6L (VIN R, Y, Z) 1.8L (VIN M) 2.0L (VIN E, F, R, U)</p> <p>FIRING ORDER 1 - 3 - 4 - 2 + - + - CYLINDER POLARITY</p> <p>CYLINDER PAIRS 1 &amp; 4 3 &amp; 2</p> <p><small>© 1999 Snap-on Technologies Inc.</small></p>
Chrysler	4	2.0L	C, Y	<p>COIL PACK LOCATION CENTER OF VALVE COVER</p> <p>FRONT OF ENGINE</p> <p>CYLINDER LOCATION</p> <p>FRONT OF VEHICLE</p> <p>CHRYSLER MITSUBISHI 2.0L (VIN C &amp; Y) 2.4L (VIN X)</p> <p>FIRING ORDER 1 - 3 - 4 - 2 + - + - CYLINDER POLARITY</p> <p>CYLINDER PAIRS 1 &amp; 4 3 &amp; 2</p> <p><small>© 1999 Snap-on Technologies Inc.</small></p>
Chrysler	4	2.0L	E, F, R, U	<p>COIL PACK LOCATION UNDER INTAKE MANIFOLD COVER</p> <p>FRONT OF ENGINE</p> <p>CYLINDER LOCATION</p> <p>FRONT OF VEHICLE</p> <p>CHRYSLER MITSUBISHI HYUNDAI 1.6L (VIN R, Y, Z) 1.8L (VIN M) 2.0L (VIN E, F, R, U)</p> <p>FIRING ORDER 1 - 3 - 4 - 2 + - + - CYLINDER POLARITY</p> <p>CYLINDER PAIRS 1 &amp; 4 3 &amp; 2</p> <p><small>© 1999 Snap-on Technologies Inc.</small></p>
Chrysler	4	2.4L	X	<p>COIL PACK LOCATION CENTER OF VALVE COVER</p> <p>FRONT OF ENGINE</p> <p>CYLINDER LOCATION</p> <p>FRONT OF VEHICLE</p> <p>CHRYSLER MITSUBISHI 2.0L (VIN C &amp; Y) 2.4L (VIN X)</p> <p>FIRING ORDER 1 - 3 - 4 - 2 + - + - CYLINDER POLARITY</p> <p>CYLINDER PAIRS 1 &amp; 4 3 &amp; 2</p> <p><small>© 1999 Snap-on Technologies Inc.</small></p>
Chrysler	6	2.7L		<p>CYLINDER LOCATION</p> <p>FRONT OF ENGINE FRONT OF VEHICLE</p> <p>CHRYSLER 2.7 / 3.2 / 3.5 COIL PER CYLINDER</p> <p>FIRING ORDER 1 - 2 - 3 - 4 - 5 - 6 + - + - + - CYLINDER POLARITY</p> <p>IGNITION COIL</p> <p><small>© 1999 Snap-on Technologies Inc.</small></p>

Table C-1 Engine data overview

Make	Cyl.	Size	VIN	Info
Chrysler	6	3.0L	B, C, J, K	<p>CHRYSLER MITSUBISHI 3.0L B,C,J,K</p> <p>CYLINDER PAIRS 1&amp;4 2&amp;5 3&amp;6</p> <p>FIRING ORDER 1-2-3-4-5-6 - + - + - + CYLINDER POLARITY</p>
Chrysler	6	3.0L	B, C, J, K	<p>CHRYSLER MITSUBISHI 3.0L B,C,J,K</p> <p>CYLINDER PAIRS 1&amp;4 2&amp;5 3&amp;6</p> <p>FIRING ORDER 1-2-3-4-5-6 - + - + - + CYLINDER POLARITY</p>
Chrysler	6	3.2L		<p>CHRYSLER 2.7 / 3.2 / 3.5 COIL PER CYLINDER</p> <p>FIRING ORDER 1-2-3-4-5-6 CYLINDER POLARITY</p> <p>IGNITION COIL</p>
Chrysler	6	3.3L	T	<p>CHRYSLER 3.3L (VIN T) 3.5L (VIN F)</p> <p>CYLINDER PAIRS 1-4 2-5 3-6</p> <p>FIRING ORDER 1-2-3-4-5-6 OR - - + + - - CYLINDER POLARITY</p>
Chrysler	6	3.3L	R, C, J	<p>CHRYSLER 3.3L (VIN T) 3.5L (VIN F)</p> <p>CYLINDER PAIRS 1-4 2-5 3-6</p> <p>FIRING ORDER 1-2-3-4-5-6 OR - - + + - - CYLINDER POLARITY</p>



Table C-1 Engine data overview

Make	Cyl.	Size	VIN	Info
Chrysler	6	3.5L	F	<p>3.5L (VIN F) COIL PACK LOCATION ON RIGHT CYLINDER HEAD</p> <p>CYLINDER LOCATION</p> <p>FRONT OF ENGINE FRONT OF VEHICLE</p> <p>3.5L (VIN T) 3.5L (VIN F)</p> <p>CYLINDER PAIRS 1-4 2-5 3-6</p> <p>FIRING ORDER 1-2-3-4-5-6 OR - - + + + - CYLINDER POLARITY</p> <p>3.3L (VIN T) COIL PACK LOCATION ON SIDE OF LEFT VALVE COVER</p> <p>© 1999 Snap-on Technologies Inc.</p>
Chrysler	6	3.5L		<p>CYLINDER LOCATION</p> <p>FRONT OF ENGINE FRONT OF VEHICLE</p> <p>CHRYSLER 2.7 / 3.2 / 3.5 COIL PER CYLINDER</p> <p>FIRING ORDER 1-2-3-4-5-6 CYLINDER POLARITY</p> <p>IGNITION COIL</p> <p>© 1999 Snap-on Technologies Inc.</p>
Chrysler	6	3.8L	L	<p>3.5L (VIN F) COIL PACK LOCATION ON RIGHT CYLINDER HEAD</p> <p>CYLINDER LOCATION</p> <p>FRONT OF ENGINE FRONT OF VEHICLE</p> <p>3.3L (VIN T) COIL PACK LOCATION ON SIDE OF LEFT VALVE COVER</p> <p>CHRYSLER 3.3L (VIN T) 3.5L (VIN F)</p> <p>CYLINDER PAIRS 1-4 2-5 3-6</p> <p>FIRING ORDER 1-2-3-4-5-6 OR - - + + + - CYLINDER POLARITY</p> <p>© 1999 Snap-on Technologies Inc.</p>
Chrysler	10	8.0L		<p>CYLINDER LOCATION</p> <p>FRONT OF ENGINE FRONT OF VEHICLE</p> <p>CHRYSLER 8.0L V10</p> <p>FIRING ORDER 1-10-9-4-3-6-5-8-7-2 + - + - + - + - + -</p> <p>CYLINDER PAIRS 1-6 2-3 4-7 5-10 8-9</p> <p>© 1999 Snap-on Technologies Inc.</p>
Dodge Monaco	6		U	<p>CYLINDER LOCATION</p> <p>FRONT OF VEHICLE</p> <p>EAGLE PREMIER DODGE MONACO 1988-92 VIN "U"</p> <p>FIRING ORDER 1-6-3-5-2-4 + - + + + - CYLINDER POLARITY</p> <p>CYLINDER PAIRS 1-5 2-6 3-4</p>

Table C-1 Engine data overview

Make	Cyl.	Size	VIN	Info
Eagle Premier	6		U	<p><b>CYLINDER LOCATION</b></p> <p>4 1 5 2 6 3</p> <p>FRONT OF VEHICLE</p> <p><b>EAGLE PREMIER DODGE MONACO 1988-92 VIN "U"</b></p> <p><b>FIRING ORDER</b> 1-6-3-5-2-4 + - + - + - <b>CYLINDER POLARITY</b></p> <p><b>CYLINDER PAIRS</b> 1-5 2-6 3-4</p>
Ford	4	1.5L	J	<p><b>FRONT OF ENGINE</b></p> <p>1 2 3 4</p> <p><b>CYLINDER LOCATION</b></p> <p>FRONT OF VEHICLE</p> <p><b>COIL PACK LOCATION</b></p> <p>3 2 4 1</p> <p><b>FORD 2.0L (VIN P) 1.9L (VIN J)</b></p> <p><b>FIRING ORDER</b> 1-3-4-2 - - + + <b>CYLINDER POLARITY</b></p> <p><b>CYLINDER PAIRS</b> 1-4 3-2</p> <p>© 1999 Snap-on Technologies Inc.</p>
Ford	4	2.0L	3, Z	<p><b>FRONT OF ENGINE</b></p> <p>1 2 3 4</p> <p><b>CYLINDER LOCATION</b></p> <p>FRONT OF VEHICLE</p> <p><b>COIL PACK LOCATION</b></p> <p>3 2 4 1</p> <p><b>FORD 2.0L VIN 3, Z</b></p> <p><b>FIRING ORDER</b> 1-3-4-2 - - + + OR - + + - <b>CYLINDER POLARITY</b></p> <p><b>CYLINDER PAIRS</b> 1-4 3-2</p> <p>© 1999 Snap-on Technologies Inc.</p>
Ford	4	2.0L	P	<p><b>FRONT OF ENGINE</b></p> <p>1 2 3 4</p> <p><b>CYLINDER LOCATION</b></p> <p>FRONT OF VEHICLE</p> <p><b>COIL PACK LOCATION</b></p> <p>3 2 4 1</p> <p><b>FORD 2.0L (VIN P) 1.9L (VIN J)</b></p> <p><b>FIRING ORDER</b> 1-3-4-2 - - + + <b>CYLINDER POLARITY</b></p> <p><b>CYLINDER PAIRS</b> 1-4 3-2</p> <p>© 1999 Snap-on Technologies Inc.</p>
Ford	4	2.5L	C	<p><b>CYLINDER LOCATION</b></p> <p>4 3 2 1</p> <p><b>FRONT OF ENGINE</b></p> <p>FRONT OF VEHICLE</p> <p><b>LEFT COIL PACK LOCATION BELOW LEFT FRONT OF INTAKE MANIFOLD</b></p> <p><b>RIGHT COIL PACK LOCATION RIGHT FRONT OF VALVE COVER</b></p> <p><b>FORD/MAZDA 2.5L DUAL PLUGS (VIN C)</b></p> <p><b>FIRING ORDER</b> 1-3-4-2 - - + + <b>CYLINDER POLARITY FOR LEFT COIL PACK</b></p> <p><b>FIRING ORDER</b> 1-3-4-2 - - + + <b>CYLINDER POLARITY FOR RIGHT COIL PACK</b></p> <p><b>CYLINDER PAIRS</b> 1-4 3-2</p> <p><b>ALTERNATE COIL PACK LOCATION</b></p> <p>RIGHT COIL LEFT COIL</p>

Table C-1 Engine data overview

Make	Cyl.	Size	VIN	Info
Ford	6	2.5L	L	<p>COIL PACK LOCATION</p> <p>FRONT OF ENGINE</p> <p>CYLINDER LOCATION</p> <p>FRONT OF VEHICLE ↓</p> <p>FORD 2.5L (VIN L) 3.0L (VIN S) 3.0L (VIN U)</p> <p>FIRING ORDER 1-4-2-5-3-6 + - + - + -</p> <p>CYLINDER POLARITY</p> <p>CYLINDER PAIRS 1 &amp; 5 3 &amp; 4 2 &amp; 6</p> <p>© 1999 Snap-on Technologies Inc.</p>
Ford	6	3.0L	S, U, Y	<p>COIL PACK LOCATION VIN S →</p> <p>FRONT OF ENGINE</p> <p>CYLINDER LOCATION</p> <p>FRONT OF VEHICLE ↓</p> <p>FORD 3.0L (VIN U &amp; Y) 3.0L (VIN S)</p> <p>FIRING ORDER 1-4-2-5-3-6 + - + - + -</p> <p>CYLINDER POLARITY</p> <p>CYLINDER PAIRS 1 &amp; 5 3 &amp; 4 2 &amp; 6</p> <p>© 1999 Snap-on Technologies Inc.</p>
Ford	6	3.0L	S	<p>COIL PACK LOCATION</p> <p>FRONT OF ENGINE</p> <p>CYLINDER LOCATION</p> <p>FRONT OF VEHICLE ↓</p> <p>FORD 2.5L (VIN L) 3.0L (VIN S) 3.0L (VIN U)</p> <p>FIRING ORDER 1-4-2-5-3-6 + - + - + -</p> <p>CYLINDER POLARITY</p> <p>CYLINDER PAIRS 1 &amp; 5 3 &amp; 4 2 &amp; 6</p> <p>© 1999 Snap-on Technologies Inc.</p>
Ford	6	3.0L	U	<p>COIL PACK LOCATION</p> <p>FRONT OF ENGINE</p> <p>CYLINDER LOCATION</p> <p>FRONT OF VEHICLE ↓</p> <p>FORD 2.5L (VIN L) 3.0L (VIN S) 3.0L (VIN U)</p> <p>FIRING ORDER 1-4-2-5-3-6 + - + - + -</p> <p>CYLINDER POLARITY</p> <p>CYLINDER PAIRS 1 &amp; 5 3 &amp; 4 2 &amp; 6</p> <p>© 1999 Snap-on Technologies Inc.</p>
Ford	6	3.8L	C, R	<p>CYLINDER LOCATION</p> <p>FRONT OF ENGINE</p> <p>FRONT OF VEHICLE ↓</p> <p>FORD 3.8L (VIN C &amp; R)</p> <p>FIRING ORDER 1-4-2-5-3-6 + - + - + -</p> <p>CYLINDER POLARITY</p> <p>CYLINDER PAIRS 1-5 3-4 2-6</p> <p>© 1999 Snap-on Technologies Inc.</p>

**Coil Information**

**Table C-1** Engine data overview

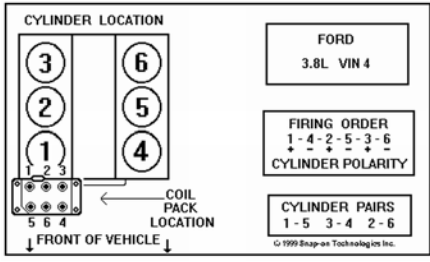
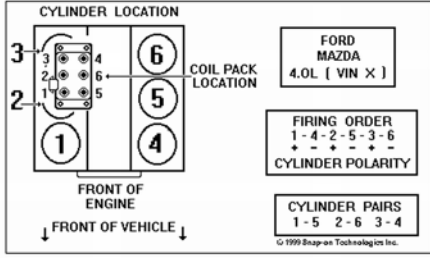
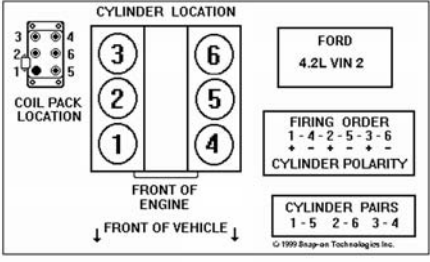
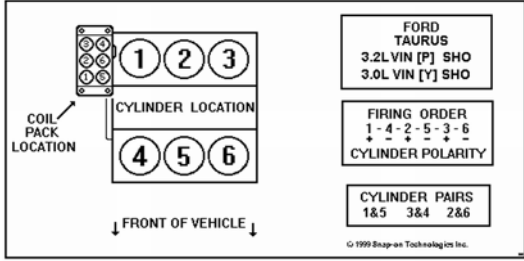
Make	Cyl.	Size	VIN	Info
Ford	6	3.8L	4	 <p><b>CYLINDER LOCATION</b></p> <p><b>FORD</b> 3.8L VIN 4</p> <p><b>FIRING ORDER</b> 1-4-2-5-3-6</p> <p><b>CYLINDER POLARITY</b></p> <p><b>CYLINDER PAIRS</b> 1-5 3-4 2-6</p> <p>© 1999 Snap-on Technologies Inc.</p>
Ford	6	4.0L	X, E	 <p><b>CYLINDER LOCATION</b></p> <p><b>FORD</b> <b>MAZDA</b> 4.0L [VIN X]</p> <p><b>FIRING ORDER</b> 1-4-2-5-3-6</p> <p><b>CYLINDER POLARITY</b></p> <p><b>CYLINDER PAIRS</b> 1-5 2-6 3-4</p> <p>© 1999 Snap-on Technologies Inc.</p>
Ford	6	4.2L	2	 <p><b>CYLINDER LOCATION</b></p> <p><b>FORD</b> 4.2L VIN 2</p> <p><b>FIRING ORDER</b> 1-4-2-5-3-6</p> <p><b>CYLINDER POLARITY</b></p> <p><b>CYLINDER PAIRS</b> 1-5 2-6 3-4</p> <p>© 1999 Snap-on Technologies Inc.</p>
Ford	6	3.0L	Y	 <p><b>CYLINDER LOCATION</b></p> <p><b>FORD</b> <b>TAURUS</b> 3.2L VIN [P] SHO 3.0L VIN [Y] SHO</p> <p><b>FIRING ORDER</b> 1-4-2-5-3-6</p> <p><b>CYLINDER POLARITY</b></p> <p><b>CYLINDER PAIRS</b> 1&amp;5 3&amp;4 2&amp;6</p> <p>© 1999 Snap-on Technologies Inc.</p>

**Coil Information**

**Table C-1** Engine data overview

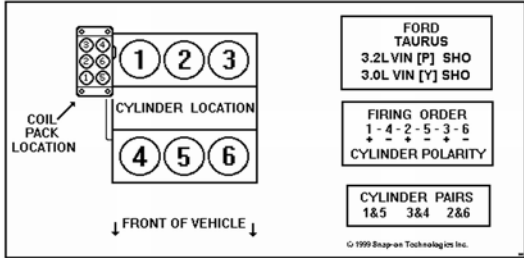
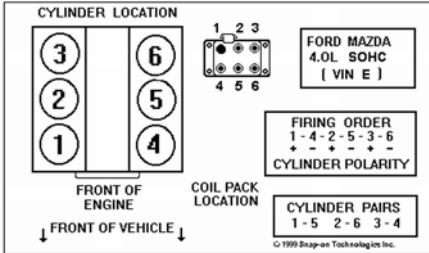
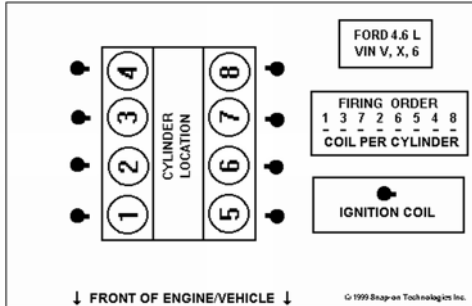
Make	Cyl.	Size	VIN	Info
Ford	6	3.2L	P	 <p>FORD TAURUS 3.2L VIN [P] SHO 3.0L VIN [Y] SHO</p> <p>FIRING ORDER 1 - 4 - 2 - 5 - 3 - 6 + - - - - + - -</p> <p>CYLINDER POLARITY</p> <p>CYLINDER PAIRS 1&amp;5 3&amp;4 2&amp;6</p> <p>© 1999 Snap-on Technologies Inc.</p>
Ford	6	4.0L	E	 <p>CYLINDER LOCATION</p> <p>FORD MAZDA 4.0L SOHC ( VIN E )</p> <p>FIRING ORDER 1 - 4 - 2 - 5 - 3 - 6 + - - - - + - -</p> <p>CYLINDER POLARITY</p> <p>CYLINDER PAIRS 1 - 5 2 - 6 3 - 4</p> <p>© 1999 Snap-on Technologies Inc.</p>
Ford	8	4.6L	V, X, 6	 <p>FORD 4.6 L VIN V, X, 6</p> <p>FIRING ORDER 1 3 7 2 6 5 4 8 - - - - - - - -</p> <p>COIL PER CYLINDER</p> <p>IGNITION COIL</p> <p>© 1999 Snap-on Technologies Inc.</p>

**Coil Information**

**Table C-1** Engine data overview

Make	Cyl.	Size	VIN	Info
Ford	8	4.6L	V, W, 9	<p>Diagram for Ford 4.6L VIN V, W, 9. Shows passenger side and driver side coil packs. Firing order: 1 3 7 2 6 5 4 8. Cylinder polarity: +-+-+-+. Cylinder pairs: 1-6 3-5 7-4 2-8. Note: IF THE PLUG WIRES ARE REMOVED POSITION THEM AS SHOWN WHEN RE-INSTALLING ENSURE THAT THE DIS RETAINER CLIP IS FULLY ENGAGED ON THE COIL TOWER.</p>
Ford	8	4.6L	V, 6, X	<p>Diagram for Ford 4.6L VIN V, 6, X. Shows passenger side and driver side coil packs. Firing order: 1 3 7 2 6 5 4 8. Cylinder polarity: +-+-+-+. Cylinder pairs: 1-6 3-5 7-4 2-8. Note: IF THE PLUG WIRES ARE REMOVED POSITION THEM AS SHOWN WHEN RE-INSTALLING ENSURE THAT THE DIS RETAINER CLIP IS FULLY ENGAGED ON THE COIL TOWER.</p>
Ford	8	5.0L	P	<p>Diagram for Ford 5.0L VIN P. Shows cylinder location and firing order: 1 3 7 2 6 5 4 8. Cylinder polarity: +-+-+-+. Cylinder pairs: 1-6 3-5 7-4 2-8. Note: IF THE PLUG WIRES ARE REMOVED POSITION THEM AS SHOWN WHEN RE-INSTALLING ENSURE THAT THE DIS RETAINER CLIP IS FULLY ENGAGED ON THE COIL TOWER.</p>

**Coil Information**

**Table C-1** Engine data overview

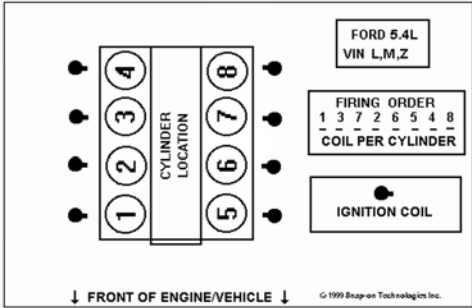
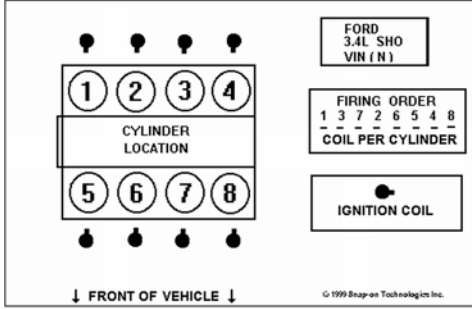
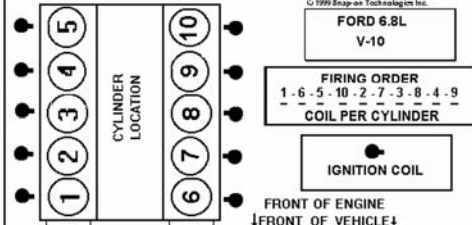
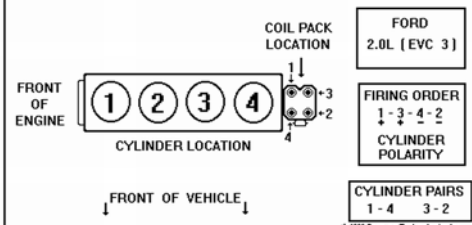
Make	Cyl.	Size	VIN	Info
Ford	8	5.4L	L, M, Z	 <p>FORD 5.4L VIN L, M, Z</p> <p>FIRING ORDER 1 3 7 2 6 5 4 8 - - - - - COIL PER CYLINDER</p> <p>IGNITION COIL</p> <p>↓ FRONT OF ENGINE/VEHICLE ↓</p> <p><small>© 1999 Snap-on Technologies Inc.</small></p>
Ford	8	3.4L	N	 <p>FORD 3.4L SHO VIN ( N )</p> <p>FIRING ORDER 1 3 7 2 6 5 4 8 - - - - - COIL PER CYLINDER</p> <p>IGNITION COIL</p> <p>↓ FRONT OF VEHICLE ↓</p> <p><small>© 1999 Snap-on Technologies Inc.</small></p>
Ford	10	6.8L		 <p><small>© 1999 Snap-on Technologies Inc.</small></p> <p>FORD 6.8L V-10</p> <p>FIRING ORDER 1 - 6 - 5 - 10 - 2 - 7 - 3 - 8 - 4 - 9 - - - - - COIL PER CYLINDER</p> <p>IGNITION COIL</p> <p>FRONT OF ENGINE ↓ FRONT OF VEHICLE ↓</p>
Ford	4	2.0L		 <p>FRONT OF ENGINE</p> <p>COIL PACK LOCATION</p> <p>FORD 2.0L (EVC 3)</p> <p>FIRING ORDER 1 - 3 - 4 - 2 - - - - - CYLINDER POLARITY</p> <p>CYLINDER PAIRS 1 - 4    3 - 2</p> <p>FRONT OF VEHICLE ↓</p> <p><small>© 1999 Snap-on Technologies Inc.</small></p>

**Coil Information**

**Table C-1** Engine data overview

Make	Cyl.	Size	VIN	Info
Ford	6	3.0L	U	<p>Truck</p> <p>CYLINDER LOCATION</p> <p>FRONT OF ENGINE</p> <p>FRONT OF VEHICLE ↓</p> <p>FORD / MAZDA TRUCK 3.0L VIN "U"</p> <p>FIRING ORDER 1-4-2-5-3-6</p> <p>CYLINDER POLARITY + - + - + -</p> <p>CYLINDER PAIRS 1-5 2-6 3-4</p> <p>© 1999 Snap-on Technologies Inc.</p>
Ford	6	3.8L	4	<p>Windstar</p> <p>COIL PACK LOCATION</p> <p>CYLINDER LOCATION</p> <p>FRONT OF ENGINE</p> <p>FRONT OF VEHICLE ↓</p> <p>FORD WINDSTAR 3.8L VIN 4</p> <p>FIRING ORDER 1-4-2-5-3-6</p> <p>CYLINDER POLARITY + - + - + -</p> <p>CYLINDER PAIRS 1&amp;5 3&amp;4 2&amp;6</p> <p>© 1999 Snap-on Technologies Inc.</p>
GM	4	2.0L	H	<p>COIL PACK LOCATION UNDER REAR OF INTAKE MANIFOLD</p> <p>COIL PACK</p> <p>FRONT OF ENGINE</p> <p>FRONT OF VEHICLE ↓</p> <p>GENERAL MOTORS 2.0L (VIN H)</p> <p>FIRING ORDER 1-3-4-2</p> <p>CYLINDER POLARITY + - + -</p> <p>CYLINDER PAIRS 1-4 2-3</p> <p>© 1999 Snap-on Technologies Inc.</p>
GM	4	2.2L	4	<p>COIL PACK IS LOCATED UNDER INTAKE MANIFOLD</p> <p>FRONT OF ENGINE</p> <p>GENERAL MOTORS 2.2L (VIN 4)</p> <p>FIRING ORDER 1-3-4-2</p> <p>CYLINDER POLARITY + - + -</p> <p>CYLINDER PAIRS 1-4 2-3</p> <p>© 1999 Snap-on Technologies Inc.</p>



**Coil Information**

**Table C-1** Engine data overview

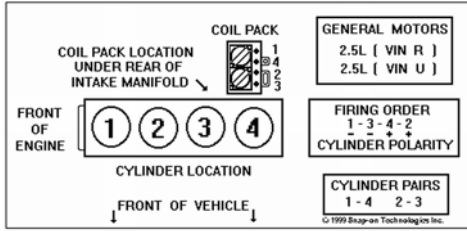
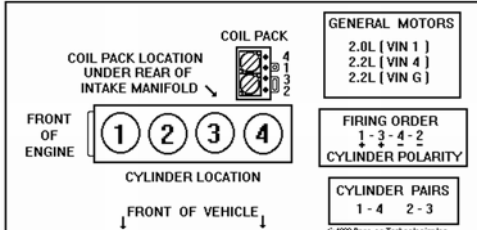
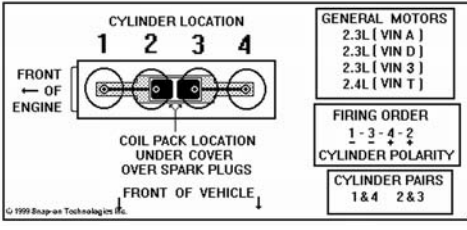
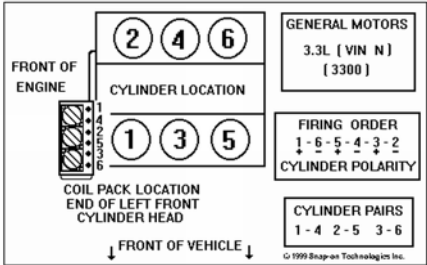
Make	Cyl.	Size	VIN	Info
GM	4	2.5L	R, U	 <p>COIL PACK LOCATION UNDER REAR OF INTAKE MANIFOLD</p> <p>FRONT OF ENGINE</p> <p>CYLINDER LOCATION</p> <p>FRONT OF VEHICLE</p> <p>COIL PACK</p> <p>GENERAL MOTORS</p> <p>2.5L [ VIN R ] 2.5L [ VIN U ]</p> <p>FIRING ORDER</p> <p>1-3-4-2</p> <p>CYLINDER POLARITY</p> <p>CYLINDER PAIRS</p> <p>1-4 2-3</p> <p>© 1999 Snap-on Technologies Inc.</p>
GM	4	2.0L, 2.2L	1 4, G	 <p>COIL PACK LOCATION UNDER REAR OF INTAKE MANIFOLD</p> <p>FRONT OF ENGINE</p> <p>CYLINDER LOCATION</p> <p>FRONT OF VEHICLE</p> <p>COIL PACK</p> <p>GENERAL MOTORS</p> <p>2.0L [ VIN 1 ] 2.2L [ VIN 4 ] 2.2L [ VIN G ]</p> <p>FIRING ORDER</p> <p>1-3-4-2</p> <p>CYLINDER POLARITY</p> <p>CYLINDER PAIRS</p> <p>1-4 2-3</p> <p>© 1999 Snap-on Technologies Inc.</p>
GM	4	2.3L, 2.4L	A, D, 3 T	 <p>CYLINDER LOCATION</p> <p>FRONT OF ENGINE</p> <p>CYLINDER LOCATION</p> <p>FRONT OF VEHICLE</p> <p>COIL PACK LOCATION UNDER COVER OVER SPARK PLUGS</p> <p>GENERAL MOTORS</p> <p>2.3L [ VIN A ] 2.3L [ VIN D ] 2.3L [ VIN 3 ] 2.4L [ VIN T ]</p> <p>FIRING ORDER</p> <p>1-3-4-2</p> <p>CYLINDER POLARITY</p> <p>CYLINDER PAIRS</p> <p>1&amp;4 2&amp;3</p> <p>© 1999 Snap-on Technologies Inc.</p>
GM	6	3.3L	N	 <p>FRONT OF ENGINE</p> <p>CYLINDER LOCATION</p> <p>FRONT OF VEHICLE</p> <p>COIL PACK LOCATION END OF LEFT FRONT CYLINDER HEAD</p> <p>GENERAL MOTORS</p> <p>3.3L [ VIN N ] [ 3300 ]</p> <p>FIRING ORDER</p> <p>1-6-5-4-3-2</p> <p>CYLINDER POLARITY</p> <p>CYLINDER PAIRS</p> <p>1-4 2-5 3-6</p> <p>© 1999 Snap-on Technologies Inc.</p>

**Coil Information**

**Table C-1** Engine data overview

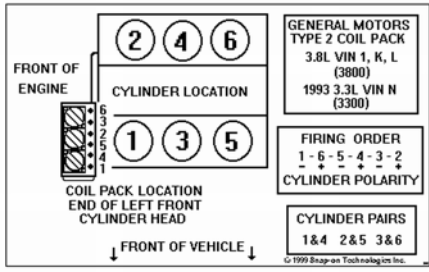
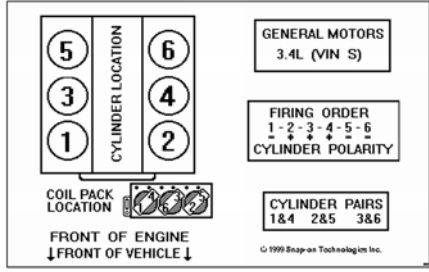
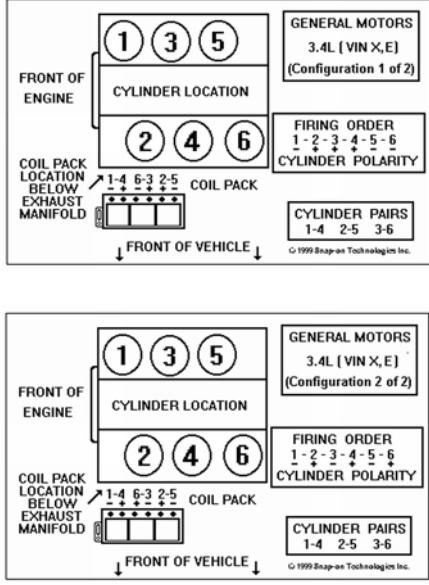
Make	Cyl.	Size	VIN	Info
GM	6	3.3L 1992		 <p>FRONT OF ENGINE</p> <p>CYLINDER LOCATION</p> <p>COIL PACK LOCATION END OF LEFT FRONT CYLINDER HEAD</p> <p>FRONT OF VEHICLE ↓</p> <p>GENERAL MOTORS TYPE 2 COIL PACK 3.8L VIN 1, K, L (3800) 1993 3.3L VIN N (3300)</p> <p>FIRING ORDER 1-6-5-4-3-2 CYLINDER POLARITY</p> <p>CYLINDER PAIRS 1&amp;4 2&amp;5 3&amp;6</p> <p>© 1999 Snap-on Technologies Inc.</p>
GM	6	3.4L	S	 <p>FRONT OF ENGINE</p> <p>CYLINDER LOCATION</p> <p>COIL PACK LOCATION</p> <p>FRONT OF ENGINE ↓ FRONT OF VEHICLE ↓</p> <p>GENERAL MOTORS 3.4L (VIN S)</p> <p>FIRING ORDER 1-2-3-4-5-6 CYLINDER POLARITY</p> <p>CYLINDER PAIRS 1&amp;4 2&amp;5 3&amp;6</p> <p>© 1999 Snap-on Technologies Inc.</p>
GM	6	3.4L	X, E	 <p>FRONT OF ENGINE</p> <p>CYLINDER LOCATION</p> <p>COIL PACK LOCATION BELOW EXHAUST MANIFOLD</p> <p>FRONT OF VEHICLE ↓</p> <p>GENERAL MOTORS 3.4L (VIN X, E) (Configuration 1 of 2)</p> <p>FIRING ORDER 1-2-3-4-5-6 CYLINDER POLARITY</p> <p>CYLINDER PAIRS 1-4 2-5 3-6</p> <p>© 1999 Snap-on Technologies Inc.</p> <p>FRONT OF ENGINE</p> <p>CYLINDER LOCATION</p> <p>COIL PACK LOCATION BELOW EXHAUST MANIFOLD</p> <p>FRONT OF VEHICLE ↓</p> <p>GENERAL MOTORS 3.4L (VIN X, E) (Configuration 2 of 2)</p> <p>FIRING ORDER 1-2-3-4-5-6 CYLINDER POLARITY</p> <p>CYLINDER PAIRS 1-4 2-5 3-6</p> <p>© 1999 Snap-on Technologies Inc.</p>

**Coil Information**

**Table C-1** Engine data overview

Make	Cyl.	Size	VIN	Info
GM	6	3.8L	K, L, 1, C	<p>FRONT OF ENGINE</p> <p>CYLINDER LOCATION</p> <p>COIL PACK LOCATION END OF LEFT FRONT CYLINDER HEAD</p> <p>FRONT OF VEHICLE ↓</p> <p>GENERAL MOTORS VIN K,L,1,C (3800)</p> <p>FIRING ORDER 1-6-5-4-3-2 -OR- -+--+</p> <p>CYLINDER POLARITY</p> <p>CYLINDER PAIRS 1-4 2-5 3-6</p> <p>© 1999 Snap-on Technologies</p>
GM	6	3.8L	K	<p>CYLINDER LOCATION</p> <p>COIL PACK LOCATION #3 CYLINDER UNDER COIL PACK</p> <p>FRONT OF VEHICLE ↓</p> <p>GENERAL MOTORS 3800 (VIN K) RWD</p> <p>FIRING ORDER 1-6-5-4-3-2 -+--+</p> <p>CYLINDER POLARITY</p> <p>CYLINDER PAIRS 1&amp;4 2&amp;5 3&amp;6</p> <p>© 1999 Snap-on Technologies Inc.</p>
GM	6	3.8L	1, K, L	<p>FRONT OF ENGINE</p> <p>CYLINDER LOCATION</p> <p>COIL PACK LOCATION END OF LEFT FRONT CYLINDER HEAD</p> <p>FRONT OF VEHICLE ↓</p> <p>GENERAL MOTORS TYPE 2 COIL PACK 3.8L VIN 1, K, L (3800) 1993 3.3L VIN N (3300)</p> <p>FIRING ORDER 1-6-5-4-3-2 -+--+</p> <p>CYLINDER POLARITY</p> <p>CYLINDER PAIRS 1&amp;4 2&amp;5 3&amp;6</p> <p>© 1999 Snap-on Technologies Inc.</p>
GM	6	3.1L 3.4L	M E	<p>FRONT OF ENGINE</p> <p>CYLINDER LOCATION</p> <p>COIL PACK LOCATED ON REAR VALVE COVER</p> <p>FRONT OF VEHICLE ↓</p> <p>GENERAL MOTORS 3.1L [VIN M ] 3.4L [VIN E ]</p> <p>FIRING ORDER 1-2-3-4-5-6 -+--+</p> <p>CYLINDER POLARITY</p> <p>CYLINDER PAIRS 1&amp;4 2&amp;5 3&amp;6</p> <p>© 1999 Snap-on Technologies Inc.</p>

Coil Information

Table C-1 Engine data overview

Make	Cyl.	Size	VIN	Info
GM	6	3.8L	C, L	<p>TYPE 1 3.8L VIN C, L</p> <p>FRONT OF ENGINE</p> <p>CYLINDER LOCATION</p> <p>COIL PACK LOCATION END OF LEFT FRONT CYLINDER HEAD</p> <p>FRONT OF VEHICLE ↓</p> <p>GENERAL MOTORS TYPE 1 COIL PACK 3.8L VIN L 3.8L VIN C (3800)</p> <p>FIRING ORDER 1-6-5-4-3-2 CYLINDER POLARITY</p> <p>CYLINDER PAIRS 1-4 2-5 3-6</p> <p>© 1999 Snap-on Technologies Inc.</p>
GM	6	3.0L 3.8L	L 3, B	<p>6 2 4 3 5 1 COIL PACK TYPE I</p> <p>6 3 2 5 4 1 COIL PACK TYPE II</p> <p>FRONT OF ENGINE</p> <p>CYLINDER LOCATION</p> <p>COIL PACK LOCATION</p> <p>FRONT OF VEHICLE ↓</p> <p>GENERAL MOTORS 3.0L [VIN L] 3.8L [VIN 3] 3.8L [VIN B]</p> <p>FIRING ORDER 1-6-5-4-3-2 CYLINDER POLARITY</p> <p>CYLINDER PAIRS 1-4 2-5 3-6</p> <p>© 1999 Snap-on Technologies Inc.</p>
GM	6	3.3L 1989- 1992	N	<p>1989-92 3.3L VIN N</p> <p>FRONT OF ENGINE</p> <p>CYLINDER LOCATION</p> <p>COIL PACK LOCATION END OF LEFT FRONT CYLINDER HEAD</p> <p>FRONT OF VEHICLE ↓</p> <p>GENERAL MOTORS 1989-1992 3.3L [VIN N] (3300)</p> <p>FIRING ORDER 1-6-5-4-3-2 CYLINDER POLARITY</p> <p>CYLINDER PAIRS 1-4 2-5 3-6</p> <p>© 1999 Snap-on Technologies Inc.</p>
GM	6	2.8L 3.1L 3.4L 1991- 1993	W T, V X	<p>FRONT OF ENGINE</p> <p>CYLINDER LOCATION</p> <p>COIL PACK LOCATION BELOW FRONT EXHAUST MANIFOLD</p> <p>FRONT OF VEHICLE ↓</p> <p>GENERAL MOTORS 2.8L [VIN W] 3.1L [VIN T] 3.1L [VIN V 1] 91-93 3.4L [VIN X]</p> <p>FIRING ORDER 1-2-3-4-5-6 CYLINDER POLARITY</p> <p>CYLINDER PAIRS 1-4 2-5 3-6</p> <p>© 1999 Snap-on Technologies Inc.</p>

Table C-1 Engine data overview

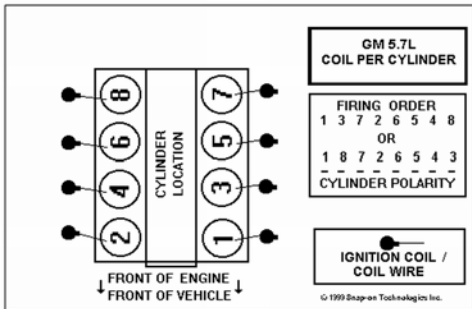
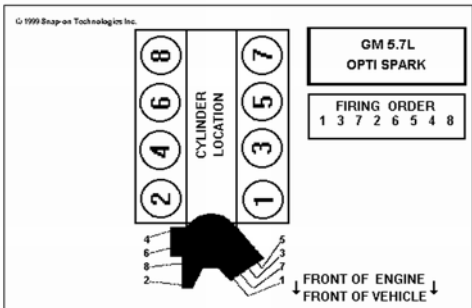
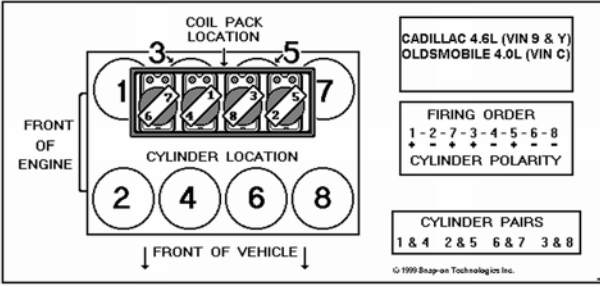
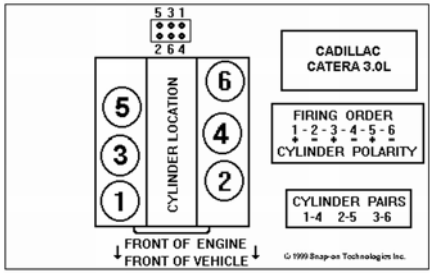
Make	Cyl.	Size	VIN	Info
GM	8	5.7L		 <p>GM 5.7L COIL PER CYLINDER</p> <p>FIRING ORDER 1 3 7 2 6 5 4 8 OR 1 8 7 2 6 5 4 3 CYLINDER POLARITY</p> <p>IGNITION COIL / COIL WIRE</p> <p>© 1999 Snap-on Technologies Inc.</p>
GM	8	5.7L		<p>OPTI spark system</p>  <p>GM 5.7L OPTI SPARK</p> <p>FIRING ORDER 1 3 7 2 6 5 4 8</p> <p>© 1999 Snap-on Technologies Inc.</p>
GM—Cadillac	8	4.6L	9, Y	 <p>COIL PACK LOCATION</p> <p>CADILLAC 4.6L (VIN 9 &amp; Y) OLDSMOBILE 4.0L (VIN C)</p> <p>FIRING ORDER 1-2-7-3-4-5-6-8 CYLINDER POLARITY</p> <p>CYLINDER PAIRS 1 &amp; 4 2 &amp; 5 6 &amp; 7 3 &amp; 8</p> <p>© 1999 Snap-on Technologies Inc.</p>
GM—Catera	6	3.0L		 <p>CADILLAC CATERA 3.0L</p> <p>FIRING ORDER 1-2-3-4-5-6 CYLINDER POLARITY</p> <p>CYLINDER PAIRS 1-4 2-5 3-6</p> <p>© 1999 Snap-on Technologies Inc.</p>

**Coil Information**

**Table C-1** Engine data overview

Make	Cyl.	Size	VIN	Info
GM—Chevrolet	8	5.7L	G	 <p>CHEVROLET 5.7L (VIN G)</p> <p>FRONT OF ENGINE FRONT OF VEHICLE</p> <p>CYLINDER LOCATION</p> <p>COIL PACK LOCATION UNDER PLENUM</p> <p>FIRING ORDER 1-8-4-3-6-5-7-2</p> <p>CYLINDER POLARITY</p> <p>CYLINDER PAIRS 1-6 2-3 4-7 5-8</p> <p>© 1999 Snap-on Technologies Inc.</p>
GM—Chevrolet Corvette ZR1	8	5.7L	J	 <p>CHEVROLET CORVETTE ZR1 5.7L (VIN J)</p> <p>FRONT OF ENGINE FRONT OF VEHICLE</p> <p>CYLINDER LOCATION</p> <p>COIL PACK LOCATION UNDER PLENUM</p> <p>FIRING ORDER 1-8-4-3-6-5-7-2</p> <p>CYLINDER POLARITY</p> <p>CYLINDER PAIRS 1-6 2-3 4-7 5-8</p> <p>© 1999 Snap-on Technologies Inc.</p>
GM— Oldsmobile	8	4L	C	 <p>COIL PACK LOCATION</p> <p>FRONT OF ENGINE</p> <p>CYLINDER LOCATION</p> <p>FRONT OF VEHICLE</p> <p>CADILLAC 4.6L (VIN 9 &amp; Y) OLDSMOBILE 4.0L (VIN C)</p> <p>FIRING ORDER 1-2-7-3-4-5-6-8</p> <p>CYLINDER POLARITY</p> <p>CYLINDER PAIRS 1 &amp; 4 2 &amp; 5 6 &amp; 7 3 &amp; 8</p> <p>© 1999 Snap-on Technologies Inc.</p>
Honda	6			 <p>CYLINDER LOCATION</p> <p>FRONT OF ENGINE FRONT OF VEHICLE</p> <p>HONDA / ACURA V6 COIL PER CYLINDER</p> <p>FIRING ORDER 1-4-2-5-3-6</p> <p>CYLINDER POLARITY</p> <p>IGNITION COIL</p> <p>© 1999 Snap-on Technologies Inc.</p>

Table C-1 Engine data overview

Make	Cyl.	Size	VIN	Info
Honda	6	3.2L	V, W	 <p>ISUZU HONDA 3.2L VIN V, W</p> <p>FIRING ORDER 1-2-3-4-5-6 CYLINDER POLARITY</p> <p>CYLINDER PAIRS 1&amp;4 2&amp;5 3&amp;6</p> <p>© 1999 Snap-on Technologies Inc.</p>
Honda	6			 <p>HONDA / ACURA V6 COIL PER CYLINDER</p> <p>FIRING ORDER 1-4-2-5-3-6 CYLINDER POLARITY</p> <p>IGNITION COIL</p> <p>© 1999 Snap-on Technologies Inc.</p>
Honda— Passport 1993–1995	6			 <p>Honda Passport 1993 - 1995 Isuzu Rodeo 1993 - 1995 Isuzu Trooper 1992 - 1995</p> <p>FIRING ORDER 1-2-3-4-5-6 CYLINDER POLARITY</p> <p>COIL PACK CYLINDER PAIRS 1-4 2-5 3-6</p> <p>© 1999 Snap-on Technologies</p>
Honda— Passport	6	3.2L, 3.5L		 <p>HONDA PASSPORT 3.2L / 3.5L COIL PER CYLINDER</p> <p>FIRING ORDER 1-2-3-4-5-6 CYLINDER POLARITY</p> <p>IGNITION COIL</p> <p>© 1999 Snap-on Technologies Inc.</p>

Table C-1 Engine data overview

Make	Cyl.	Size	VIN	Info
Hyundai	4	1.5L		<p>MITSUBISHI HYUNDAI 1.5L</p> <p>CYLINDER LOCATION: 1 2 3 4</p> <p>FRONT OF VEHICLE ↓</p> <p>FIRING ORDER: 1-3-4-2</p> <p>CYLINDER POLARITY: - + - +</p> <p>CYLINDER PAIRS: 1-4 3-2</p> <p>© 1999 Snap-on Technologies Inc.</p>
Hyundai	4	1.5L	N	<p>HYUNDAI 1.5L VIN N</p> <p>CYLINDER LOCATION: 1 2 3 4</p> <p>FRONT OF VEHICLE ↓</p> <p>FIRING ORDER: 1-3-4-2</p> <p>CYLINDER POLARITY: + + - -</p> <p>CYLINDER PAIRS: 1-4 3-2</p> <p>© 1999 Snap-on Technologies Inc.</p>
Hyundai	4	1.5L	N	<p>HYUNDAI 1.5L VIN N</p> <p>CYLINDER LOCATION: 1 2 3 4</p> <p>FRONT OF VEHICLE ↓</p> <p>FIRING ORDER: 1-3-4-2</p> <p>CYLINDER POLARITY: + + - -</p> <p>CYLINDER PAIRS: 1-4 3-2</p> <p>© 1999 Snap-on Technologies Inc.</p>
Hyundai	4	1.6L 1.8L 2.0L	R, Y, Z M E, F, R, U	<p>COIL PACK LOCATION UNDER INTAKE MANIFOLD COVER</p> <p>FRONT OF ENGINE</p> <p>FRONT OF VEHICLE ↓</p> <p>CYLINDER LOCATION: 4 3 2 1</p> <p>CHRYSLER MITSUBISHI HYUNDAI 1.6L (VIN R, Y, Z) 1.8L (VIN M) 2.0L (VIN E, F, R, U)</p> <p>FIRING ORDER: 1-3-4-2</p> <p>CYLINDER POLARITY: - + - +</p> <p>CYLINDER PAIRS: 1&amp;4 3&amp;2</p> <p>© 1999 Snap-on Technologies Inc.</p>

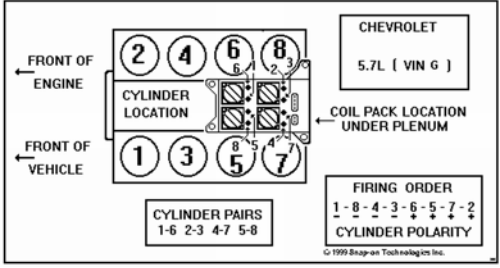
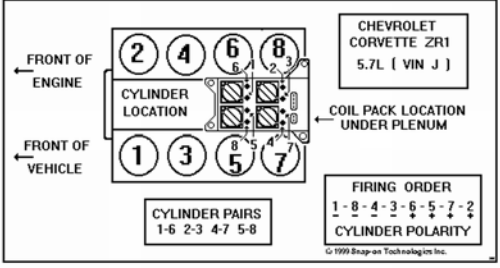
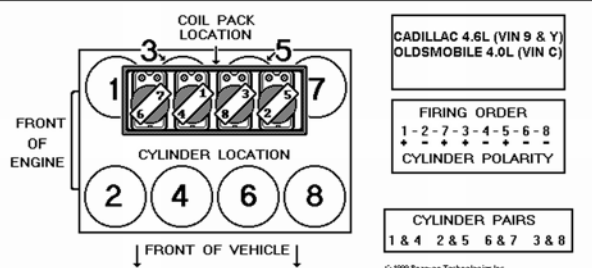
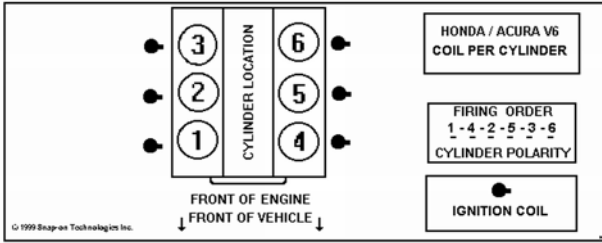

# Coil Information

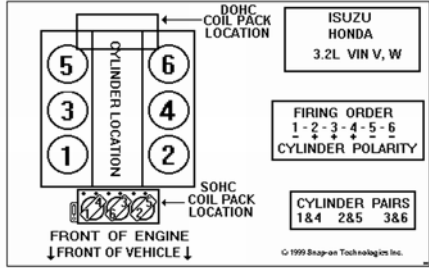
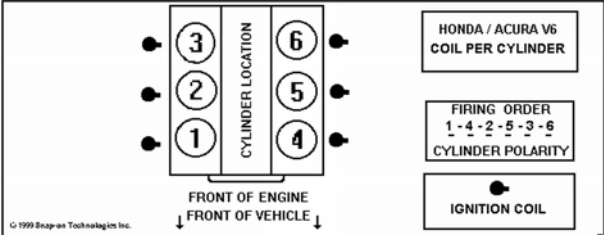
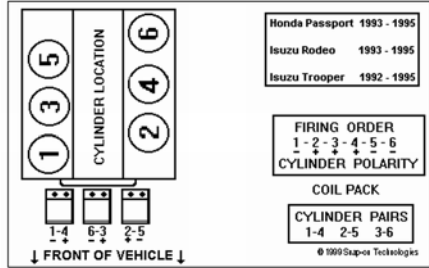
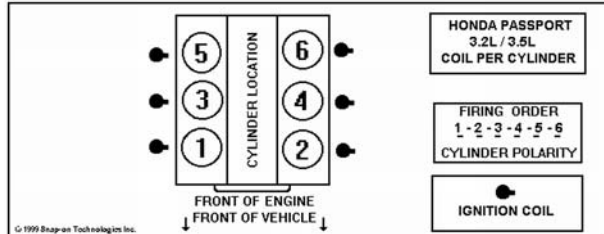
**Table C-1** Engine data overview

Make	Cyl.	Size	VIN	Info
Infiniti	6	3.0L	J	<p>INFINITI 1992-99 J30 COIL PER CYLINDER</p> <p>FIRING ORDER 1-2-3-4-5-6 CYLINDER POLARITY</p> <p>IGNITION COIL</p> <p>FRONT OF ENGINE FRONT OF VEHICLE ↓</p> <p>© 1999 Snap-on Technologies Inc.</p>
Infiniti	8	4.1L, 4.5L		<p>INFINITI 4.1L - 4.5L</p> <p>FIRING ORDER 1-8-7-3-6-5-4-2 COIL PER CYLINDER</p> <p>IGNITION COIL</p> <p>FRONT OF ENGINE/VEHICLE ↓</p> <p>© 1999 Snap-on Technologies Inc.</p>
Isuzu	6	3.2L	V, W	<p>DOHC COIL PACK LOCATION</p> <p>ISUZU HONDA 3.2L VIN V, W</p> <p>FIRING ORDER 1-2-3-4-5-6 CYLINDER POLARITY</p> <p>SOHC COIL PACK LOCATION</p> <p>CYLINDER PAIRS 1&amp;4 2&amp;5 3&amp;6</p> <p>FRONT OF ENGINE FRONT OF VEHICLE ↓</p> <p>© 1999 Snap-on Technologies Inc.</p>
Isuzu—Rodeo 1993–1995	6			<p>Honda Passport 1993 - 1995 Isuzu Rodeo 1993 - 1995 Isuzu Trooper 1992 - 1995</p> <p>FIRING ORDER 1-2-3-4-5-6 CYLINDER POLARITY</p> <p>COIL PACK</p> <p>CYLINDER PAIRS 1-4 2-5 3-6</p> <p>FRONT OF VEHICLE ↓</p> <p>© 1999 Snap-on Technologies</p>

Table C-1 Engine data overview

Make	Cyl.	Size	VIN	Info
Isuzu—Rodeo	6	3.2L 3.5L		 <p>RODEO / TROOPER 3.2L / 3.5L COIL PER CYLINDER</p> <p>FIRING ORDER 1 - 2 - 3 - 4 - 5 - 6 CYLINDER POLARITY</p> <p>IGNITION COIL</p> <p>FRONT OF ENGINE FRONT OF VEHICLE ↓</p> <p>© 1999 Snap-on Technologies Inc.</p>
Isuzu—Trooper 1992–19985	6			 <p>Honda Passport 1993 - 1995 Isuzu Rodeo 1993 - 1995 Isuzu Trooper 1992 - 1995</p> <p>FIRING ORDER 1 - 2 - 3 - 4 - 5 - 6 CYLINDER POLARITY</p> <p>COIL PACK</p> <p>CYLINDER PAIRS 1-4 2-5 3-6</p> <p>FRONT OF VEHICLE ↓</p> <p>© 1999 Snap-on Technologies</p>
Isuzu—Trooper	6	3.2L, 3.5L		 <p>RODEO / TROOPER 3.2L / 3.5L COIL PER CYLINDER</p> <p>FIRING ORDER 1 - 2 - 3 - 4 - 5 - 6 CYLINDER POLARITY</p> <p>IGNITION COIL</p> <p>FRONT OF ENGINE FRONT OF VEHICLE ↓</p> <p>© 1999 Snap-on Technologies Inc.</p>
Kia	6	3.5L		 <p>KIA 3.5L WASTE SPARK</p> <p>FIRING ORDER 1 - 2 - 3 - 4 - 5 - 6 CYLINDER POLARITY</p> <p>CYLINDER PAIRS 1-4 2-5 3-6</p> <p>IGNITION COIL</p> <p>FRONT OF ENGINE FRONT OF VEHICLE ↓</p> <p>© 1999 Snap-on Technologies, Inc.</p>

Table C-1 Engine data overview

Make	Cyl.	Size	VIN	Info
Land Rover— Range Rover	8	4.0L		<p>Diagram showing cylinder locations 1-8 and firing order 1-8-4-3-6-5-7-2. Coil polarity is indicated as + + + +.</p> <p><b>RANGE ROVER</b> 4.0L / 4.6L</p> <p><b>FIRING ORDER</b> 1-8-4-3-6-5-7-2 - - - + + + + <b>COIL POLARITY</b></p> <p><b>COIL PAIRS</b> 1-6 8-5 4-7 3-2</p> <p>FRONT OF ENGINE FRONT OF VEHICLE</p> <p>© 1999 Snap-on Technologies Inc.</p>
Land Rover— Range Rover	8	4.6L		<p>Diagram showing cylinder locations 1-8 and firing order 1-8-4-3-6-5-7-2. Coil polarity is indicated as + + + +.</p> <p><b>RANGE ROVER</b> 4.0L / 4.6L</p> <p><b>FIRING ORDER</b> 1-8-4-3-6-5-7-2 - - - + + + + <b>COIL POLARITY</b></p> <p><b>COIL PAIRS</b> 1-6 8-5 4-7 3-2</p> <p>FRONT OF ENGINE FRONT OF VEHICLE</p> <p>© 1999 Snap-on Technologies Inc.</p>
Lexus	6			<p>Diagram showing cylinder locations 1-6 and firing order 1-5-3-6-2-4. Ignition coil polarity is indicated as +.</p> <p><b>LEXUS I-6</b> <b>COIL PER CYLINDER</b></p> <p><b>FIRING ORDER</b> 1-5-3-6-2-4 <b>CYLINDER POLARITY</b></p> <p><b>IGNITION COIL</b></p> <p>FRONT OF VEHICLE FRONT OF ENGINE</p> <p>© 1999 Snap-on Technologies Inc.</p>
Lexus	6			<p>Diagram showing cylinder locations 1-6 and firing order 1-2-3-4-5-6. Cylinder pairs are 1-4, 2-5, 3-6.</p> <p><b>TOYOTA / LEXUS</b> <b>WASTE SPARK</b></p> <p><b>FIRING ORDER</b> 1-2-3-4-5-6 <b>CYLINDER POLARITY</b></p> <p><b>CYLINDER PAIRS</b> 1-4 2-5 3-6</p> <p>FRONT OF VEHICLE</p> <p>© 1999 Snap-on Technologies Inc.</p>

Table C-1 Engine data overview

Make	Cyl.	Size	VIN	Info
Mazda	4	1.6L		<p>4 1 2 3 *****</p> <p>4 3 2 1</p> <p>FRONT OF ENGINE</p> <p>MAZDA 1.6L, 1.8L, 1.9L</p> <p>FIRING ORDER 1 - 3 - 4 - 2 - - + +</p> <p>CYLINDER POLARITY</p> <p>CYLINDER PAIRS 1 - 4 2 - 3</p> <p>© 1999 Snap-on Technologies Inc.</p>
Mazda	4	1.8L		<p>4 1 2 3 *****</p> <p>4 3 2 1</p> <p>FRONT OF ENGINE</p> <p>MAZDA 1.6L, 1.8L, 1.9L</p> <p>FIRING ORDER 1 - 3 - 4 - 2 - - + +</p> <p>CYLINDER POLARITY</p> <p>CYLINDER PAIRS 1 - 4 2 - 3</p> <p>© 1999 Snap-on Technologies Inc.</p>
Mazda	4	1.9L		<p>4 1 2 3 *****</p> <p>4 3 2 1</p> <p>FRONT OF ENGINE</p> <p>MAZDA 1.6L, 1.8L, 1.9L</p> <p>FIRING ORDER 1 - 3 - 4 - 2 - - + +</p> <p>CYLINDER POLARITY</p> <p>CYLINDER PAIRS 1 - 4 2 - 3</p> <p>© 1999 Snap-on Technologies Inc.</p>
Mazda	4	2.5L	C	<p>CYLINDER LOCATION</p> <p>RIGHT COIL PACK LOCATION RIGHT FRONT OF VALVE COVER</p> <p>LEFT COIL PACK LOCATION BELOW LEFT FRONT OF INTAKE MANIFOLD</p> <p>FRONT OF ENGINE FRONT OF VEHICLE</p> <p>4 3 2 1</p> <p>FORD/MAZDA 2.5L DUAL PLUGS (VIN C)</p> <p>FIRING ORDER 1 - 3 - 4 - 2 + - + -</p> <p>CYLINDER POLARITY FOR LEFT COIL PACK</p> <p>FIRING ORDER 1 - 3 - 4 - 2 - - + +</p> <p>CYLINDER POLARITY FOR RIGHT COIL PACK</p> <p>CYLINDER PAIRS 1 - 4 3 - 2</p> <p>ALTERNATE COIL PACK LOCATION</p> <p>4 3 2 1</p> <p>RIGHT COIL LEFT COIL</p> <p>© 1999 Snap-on Technologies Inc.</p>

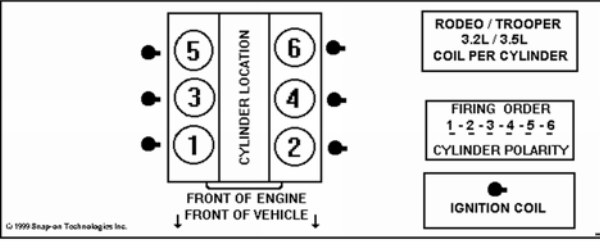
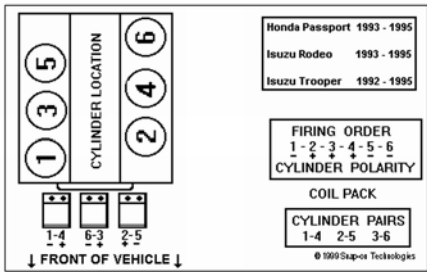
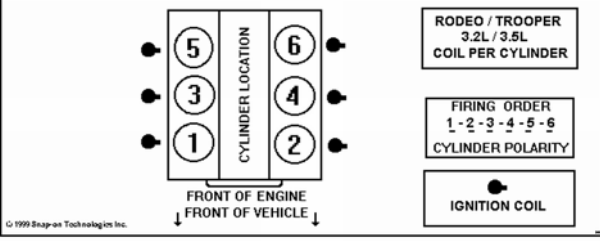
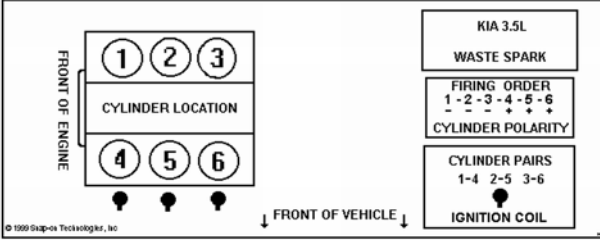
# Coil Information

**Table C-1** Engine data overview

Make	Cyl.	Size	VIN	Info
Mazda	6			<p>MAZDA MILLENNIA COIL PER CYLINDER</p> <p>FIRING ORDER 1-2-3-4-5-6</p> <p>CYLINDER POLARITY</p> <p>IGNITION COIL</p>
Mazda	6	4.0L	X, E	<p>CYLINDER LOCATION</p> <p>COIL PACK LOCATION</p> <p>FORD MAZDA 4.0L [ VIN X ]</p> <p>FIRING ORDER 1-4-2-5-3-6</p> <p>CYLINDER POLARITY + - + - + -</p> <p>CYLINDER PAIRS 1-5 2-6 3-4</p>
Mazda	6	4.0L	E	<p>CYLINDER LOCATION</p> <p>COIL PACK LOCATION</p> <p>FORD MAZDA 4.0L SOHC [ VIN E ]</p> <p>FIRING ORDER 1-4-2-5-3-6</p> <p>CYLINDER POLARITY + - + - + -</p> <p>CYLINDER PAIRS 1-5 2-6 3-4</p>
Mazda	6	3.0L	U	<p>Truck</p> <p>CYLINDER LOCATION</p> <p>COIL PACK LOCATION</p> <p>FORD / MAZDA TRUCK 3.0L VIN "U"</p> <p>FIRING ORDER 1-4-2-5-3-6</p> <p>CYLINDER POLARITY + - + - + -</p> <p>CYLINDER PAIRS 1-5 2-6 3-4</p>

**Coil Information**

**Table C-1** Engine data overview

Make	Cyl.	Size	VIN	Info
Mercedes-Benz	4			<p><b>CYLINDER LOCATION</b></p> <p>MERCEDES-BENZ INLINE 4</p> <p>FIRING ORDER 1-3-4-2 - + +</p> <p>CYLINDER POLARITY</p> <p>CYLINDER PAIRS 1-4 3-2</p> <p>FRONT OF VEHICLE ↓</p> <p><small>© 1999 Snap-on Technologies Inc.</small></p>
Mercedes-Benz	6			<p><b>CYLINDER LOCATION</b></p> <p>MERCEDES-BENZ INLINE 6</p> <p>FIRING ORDER 1-5-3-6-2-4 - - + +</p> <p>CYLINDER POLARITY</p> <p>CYLINDER PAIRS 1-6 5-2 3-4</p> <p>FRONT OF VEHICLE ↓</p> <p><small>© 1999 Snap-on Technologies Inc.</small></p>
Mercedes-Benz	6			<p><b>CYLINDER LOCATION</b></p> <p>MERCEDES-BENZ V6</p> <p>FIRING ORDER 1-4-3-6-2-5</p> <p>2 COILS / CYL 2 PLUGS / CYL</p> <p>FRONT OF VEHICLE ↓</p> <p><small>© 1999 Snap-on Technologies Inc.</small></p>
Mini Cooper	4	1.6L	C, E	<p><b>COIL PACK LOCATION</b> LOCATION CENTER OF VALVE COVER</p> <p>FRONT OF ENGINE</p> <p>FRONT OF VEHICLE ↓</p> <p>MINI Cooper 1.6L MINI Cooper S 1.6L (VIN C &amp; E)</p> <p>FIRING ORDER 1-3-4-2 - + - POLARITY</p> <p>CYLINDER PAIRS 1&amp;4 3&amp;2</p> <p><small>© 1999 Snap-on Technologies Inc.</small></p>

**Coil Information**

**Table C-1** Engine data overview

Make	Cyl.	Size	VIN	Info
Mitsubishi	4	1.5L		 <p>MITSUBISHI HYUNDAI 1.5L</p> <p>FIRING ORDER 1-3-4-2 - + - + CYLINDER POLARITY</p> <p>CYLINDER PAIRS 1-4 3-2</p> <p>© 1999 Snap-on Technologies Inc.</p>
Mitsubishi	4	2.0L 2.4L	C, Y X	 <p>COIL PACK LOCATION CENTER OF VALVE COVER</p> <p>FRONT OF ENGINE</p> <p>CYLINDER LOCATION</p> <p>FRONT OF VEHICLE</p> <p>CHRYSLER MITSUBISHI 2.0L (VIN C &amp; Y) 2.4L (VIN X)</p> <p>FIRING ORDER 1-3-4-2 + - - + CYLINDER POLARITY</p> <p>CYLINDER PAIRS 1&amp;4 3&amp;2</p> <p>© 1999 Snap-on Technologies Inc.</p>
Mitsubishi	4	1.6L 1.8L 2.0L	R, Y, Z M E, F, R, U	 <p>COIL PACK LOCATION UNDER INTAKE MANIFOLD COVER</p> <p>FRONT OF ENGINE</p> <p>CYLINDER LOCATION</p> <p>FRONT OF VEHICLE</p> <p>CHRYSLER MITSUBISHI HYUNDAI 1.6L (VIN R, Y, Z) 1.8L (VIN M) 2.0L (VIN E, F, R, U)</p> <p>FIRING ORDER 1-3-4-2 - + - + CYLINDER POLARITY</p> <p>CYLINDER PAIRS 1&amp;4 3&amp;2</p> <p>© 1999 Snap-on Technologies Inc.</p>
Mitsubishi	6	3.0L	B, C, J, K	 <p>COIL PACK LOCATION</p> <p>FRONT OF ENGINE</p> <p>CYLINDER LOCATION</p> <p>FRONT OF VEHICLE</p> <p>CHRYSLER MITSUBISHI 3.0L B,C,J,K</p> <p>CYLINDER PAIRS 1&amp;4 2&amp;5 3&amp;6</p> <p>FIRING ORDER 1-2-3-4-5-6 - + - + - + CYLINDER POLARITY</p> <p>© 1999 Snap-on Technologies Inc.</p>

Table C-1 Engine data overview

Make	Cyl.	Size	VIN	Info
Mitsubishi	6	3.0L		 <p>MITSUBISHI 3.0L V6</p> <p>CYLINDER PAIRS 1&amp;4 2&amp;5 3&amp;6</p> <p>FIRING ORDER 1 - 2 - 3 - 4 - 5 - 6 - - - + - + - CYLINDER POLARITY</p> <p>© 1999 Snap-on Technologies Inc.</p>
Mitsubishi— Galant	4	2.4L DOHC		 <p>MITSUBISHI GALANT 2.4L DOHC</p> <p>FIRING ORDER 1 - 3 - 4 - 2 - - + + CYLINDER POLARITY</p> <p>CYLINDER PAIRS 1 &amp; 4 3 &amp; 2</p> <p>© 1999 Snap-on Technologies Inc.</p>
Mitsubishi— Lancer	4	2.0L	E	 <p>MITSUBISHI 2.0L VIN E WASTE SPARK</p> <p>FIRING ORDER 1 - 3 - 4 - 2 - + - + CYLINDER POLARITY</p> <p>COIL PAIRS 1-4 3-2</p> <p>IGNITION COIL</p> <p>© 1999 Snap-on Technologies Inc.</p>
Mitsubishi— Montero	6	3.0L, 3.5L		 <p>MITSUBISHI MONTERO / MONTERO SPORT 3.0L / 3.5L</p> <p>FIRING ORDER 1 - 2 - 3 - 4 - 5 - 6 - - - + - + - CYLINDER POLARITY</p> <p>CYLINDER PAIRS 1-4 2-5 3-6</p> <p>© 1999 Snap-on Technologies Inc.</p>

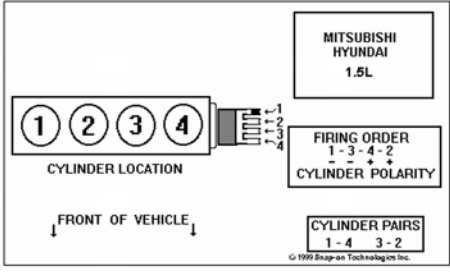
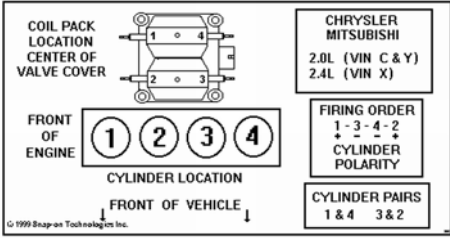
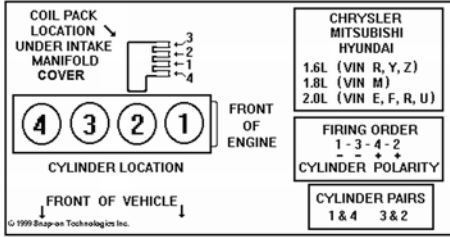
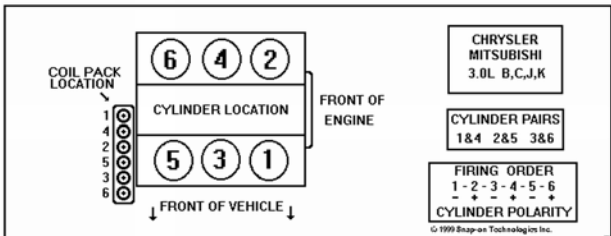

Table C-1 Engine data overview

Make	Cyl.	Size	VIN	Info
Nissan—300 ZX	6			 <p>NISSAN 300 ZX COIL PER CYLINDER</p> <p>FIRING ORDER 1-2-3-4-5-6 CYLINDER POLARITY</p> <p>IGNITION COIL</p>
Nissan—Altima	6			 <p>INFINITI ALTIMA/130/135 NISSAN MAXIMA COIL PER CYLINDER</p> <p>FIRING ORDER 1-2-3-4-5-6 CYLINDER POLARITY</p> <p>IGNITION COIL</p>
Nissan—Maxima	6			 <p>INFINITI ALTIMA/130/135 NISSAN MAXIMA COIL PER CYLINDER</p> <p>FIRING ORDER 1-2-3-4-5-6 CYLINDER POLARITY</p> <p>IGNITION COIL</p>
Nissan—Pulsar NX	4			 <p>NISSAN PULSAR NX COIL PER CYLINDER</p> <p>FIRING ORDER 1-3-4-2 CYLINDER POLARITY</p> <p>IGNITION COIL</p>

**Coil Information**

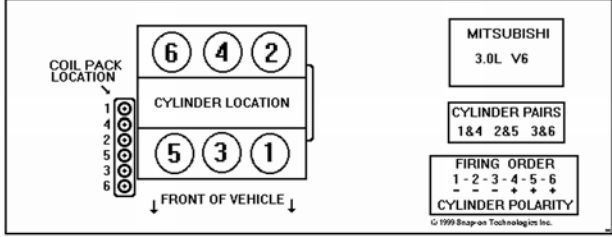
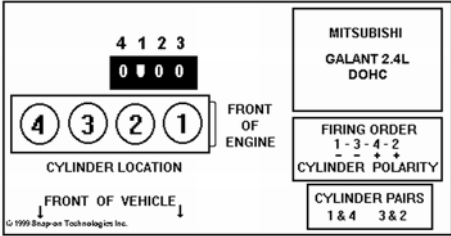
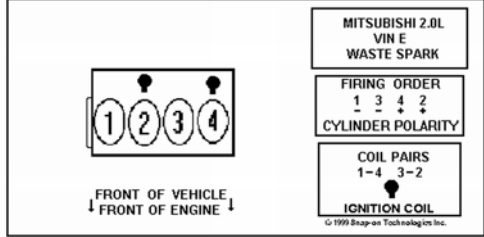
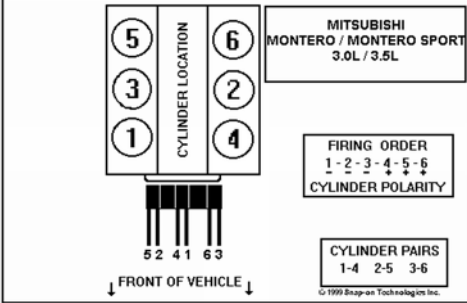
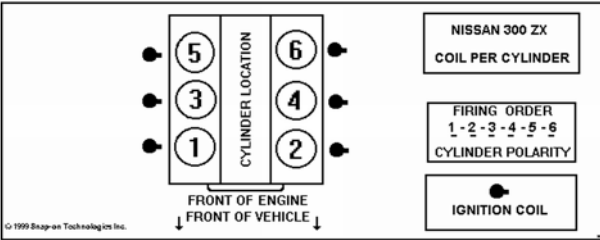
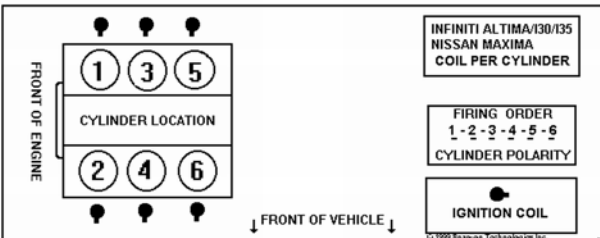
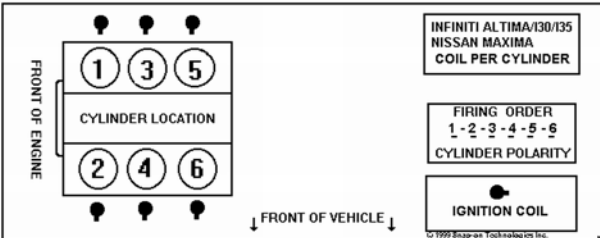
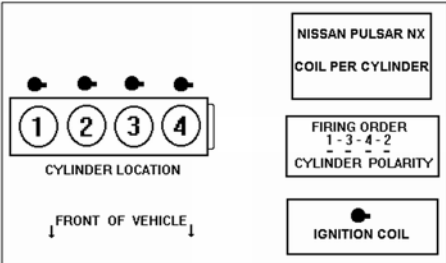
**Table C-1** Engine data overview

Make	Cyl.	Size	VIN	Info
Saab	4			 <p>SAAB 4 CYLINDER COIL PER CYLINDER</p> <p>FIRING ORDER 1-3-4-2</p> <p>CYLINDER POLARITY</p> <p>IGNITION COIL</p> <p>FRONT OF VEHICLE ↓</p> <p><small>© 1999 Snap-on Technologies Inc.</small></p>
Saturn	4	1.9L	7, 9	 <p>CYLINDER LOCATION</p> <p>FRONT OF ENGINE</p> <p>SAATURN 1.9 L VIN 7, 9</p> <p>COIL PACK LOCATION FRONT OF BELLHOUSING</p> <p>FIRING ORDER 1-3-4-2</p> <p>CYLINDER POLARITY</p> <p>CYLINDER PAIRS 1-4 2-3</p> <p>FRONT OF VEHICLE ↓</p> <p><small>© 1999 Snap-on Technologies Inc.</small></p>
Subaru	4	1.8L		 <p>CYLINDER LOCATION</p> <p>FRONT OF ENGINE ↓</p> <p>FRONT OF VEHICLE ↓</p> <p>SUBARU 1.8 L 2.2 L 2.0 L 2.5 L All engines have opposed cylinders</p> <p>FIRING ORDER 1-3-2-4</p> <p>CYLINDER POLARITY</p> <p>CYLINDER PAIRS 1-2 3-4</p>
Subaru	4	2.0L		 <p>CYLINDER LOCATION</p> <p>FRONT OF ENGINE ↓</p> <p>FRONT OF VEHICLE ↓</p> <p>SUBARU 1.8 L 2.2 L 2.0 L 2.5 L All engines have opposed cylinders</p> <p>FIRING ORDER 1-3-2-4</p> <p>CYLINDER POLARITY</p> <p>CYLINDER PAIRS 1-2 3-4</p>
Subaru	4	2.2L		 <p>CYLINDER LOCATION</p> <p>FRONT OF ENGINE ↓</p> <p>FRONT OF VEHICLE ↓</p> <p>SUBARU 1.8 L 2.2 L 2.0 L 2.5 L All engines have opposed cylinders</p> <p>FIRING ORDER 1-3-2-4</p> <p>CYLINDER POLARITY</p> <p>CYLINDER PAIRS 1-2 3-4</p>

Table C-1 Engine data overview

Make	Cyl.	Size	VIN	Info
Subaru	4	2.5L		 <p><b>CYLINDER LOCATION</b></p> <p>3 4 1 2</p> <p><b>COIL PACK LOCATION</b></p> <p>↓ FRONT OF ENGINE ↓ ↓ FRONT OF VEHICLE ↓</p> <p><b>SUBARU</b> 1.8 L 2.2 L 2.0 L 2.5 L All engines have opposed cylinders</p> <p><b>FIRING ORDER</b> 1 - 3 - 2 - 4 - + - + <b>CYLINDER POLARITY</b></p> <p><b>CYLINDER PAIRS</b> 1 - 2 3 - 4</p>
Subaru SVX	6	3.3L		 <p><b>CYLINDER LOCATION</b></p> <p>5 6 3 4 1 2</p> <p>FRONT OF ENGINE ↓ FRONT OF VEHICLE ↓</p> <p><b>SUBARU SVX</b> 3.3L All engines have opposed cylinders COIL PER CYLINDER</p> <p><b>FIRING ORDER</b> 1 - 6 - 3 - 2 - 5 - 4 - - - - - <b>CYLINDER POLARITY</b></p> <p><b>IGNITION COIL</b></p> <p>© 1999 Snap-on Technologies Inc.</p>
Toyota	4			<p>Wasted Spark</p>  <p><b>COIL PACK</b> →</p> <p><b>CYLINDER LOCATION</b></p> <p>4 3 2 1</p> <p>FRONT OF VEHICLE ↓</p> <p><b>TOYOTA</b> 4 CYLINDER WASTE SPARK</p> <p><b>FIRING ORDER</b> 1 - 3 - 4 - 2 - + - + <b>CYLINDER POLARITY</b></p> <p><b>CYLINDER PAIRS</b> 1 - 4 2 - 3</p> <p>© 1999 Snap-on Technologies Inc.</p>
Toyota	4			<p>Wasted Spark</p>  <p>SYSTEM MAY ALSO USE IGNITION COILS ON CYLS #3 &amp; #4, WITH HIGH TENSION WIRES TO CYLS #1 &amp; #2</p> <p><b>COIL PACK</b> →</p> <p><b>FRONT OF ENGINE</b></p> <p><b>CYLINDER LOCATION</b></p> <p>1 2 3 4</p> <p>FRONT OF VEHICLE ↓</p> <p><b>TOYOTA</b> 4 CYLINDER WASTE SPARK</p> <p><b>FIRING ORDER</b> 1 - 3 - 4 - 2 - + - + <b>CYLINDER POLARITY</b></p> <p><b>CYLINDER PAIRS</b> 1 - 4 2 - 3</p> <p>© 1999 Snap-on Technologies Inc.</p>
Toyota	6			 <p><b>CYLINDER LOCATION</b></p> <p>1 3 5 2 4 6</p> <p>FRONT OF VEHICLE ↓</p> <p><b>TOYOTA / LEXUS</b> WASTE SPARK</p> <p><b>FIRING ORDER</b> 1 - 2 - 3 - 4 - 5 - 6 + - + - + - <b>CYLINDER POLARITY</b></p> <p><b>CYLINDER PAIRS</b> 1 - 4 2 - 5 3 - 6</p> <p>© 1999 Snap-on Technologies Inc.</p>

## Coil Information

**Table C-1** Engine data overview

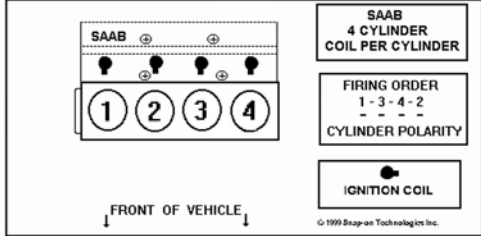
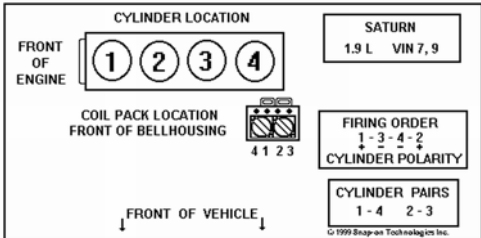
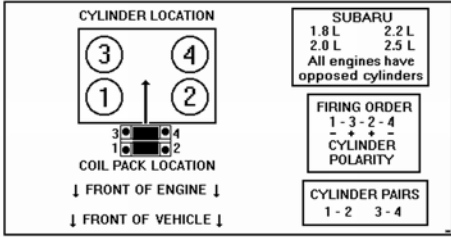
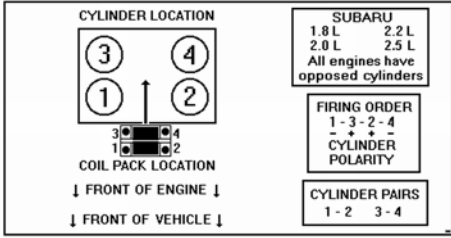
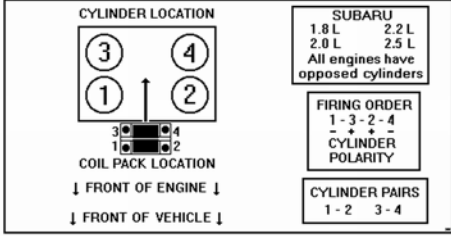
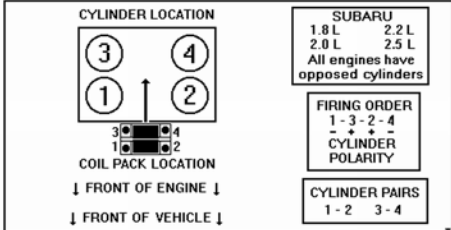
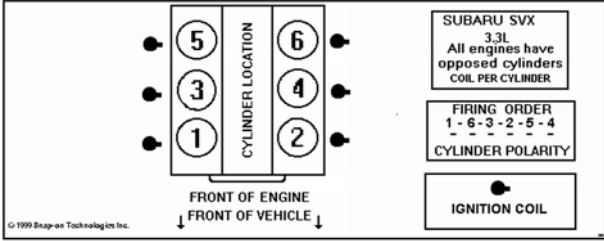
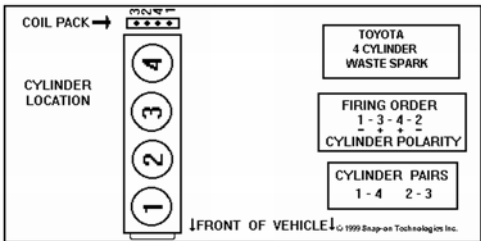
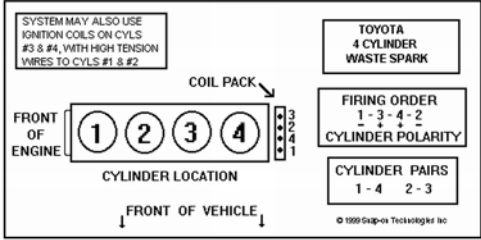
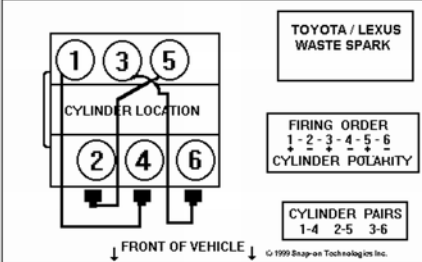
Make	Cyl.	Size	VIN	Info
Toyota	6			
Toyota	6			
Toyota	6	3.0L		
Volkswagen	4			

## Coil Information

**Table C-1** Engine data overview

Make	Cyl.	Size	VIN	Info
Volkswagen	6	2.8L		<p>FRONT OF ENGINE FRONT OF VEHICLE ↓</p> <p>CYLINDER LOCATION</p> <p>3 2 1</p> <p>6 5 4</p> <p>5 6 4 3 1 2</p> <p>AUDI / VW V6 2.8 LITER LONGITUDINAL</p> <p>CYLINDER PAIRS 1-6 4-2 3-5</p> <p>FIRING ORDER 1-4-3-6-2-5</p> <p>CYLINDER POLARITY</p> <p>© 1999 Snap-on Technologies Inc.</p>
Volkswagen	6	2.8L		<p>FRONT OF VEHICLE ↓</p> <p>CYLINDER LOCATION</p> <p>1 3 5</p> <p>2 4 6</p> <p>1 2 3 6 5 4</p> <p>AUDI / VW V6 2.8 LITER TRANSVERSE</p> <p>CYLINDER PAIRS 1-6 5-2 3-4</p> <p>FIRING ORDER 1-5-3-6-2-4</p> <p>CYLINDER POLARITY</p> <p>© 1999 Snap-on Technologies Inc.</p>
Volkswagen	8	4.0L		<p>FRONT OF ENGINE FRONT OF VEHICLE ↓</p> <p>CYLINDER LOCATION</p> <p>4 3 2 1</p> <p>8 7 6 5</p> <p>VOLKSWAGEN 4.0L W8 COIL PER CYLINDER</p> <p>FIRING ORDER 1-5-4-8-6-3-7-2</p> <p>CYLINDER POLARITY</p> <p>IGNITION COIL</p> <p>© 1999 Snap-on Technologies Inc.</p>

